

# VACUUM TUBE VALLEY<sup>®</sup>

Issue 20 Quarterly

The Classic Electronics Reference Journal

Price \$10.95

## The Space Savers 7591

**Scott 7591 Stereo  
Integrated Amps**

**299C, 299D, LK-72 and 233**



**Carr Amplification**

**Designer Profile**

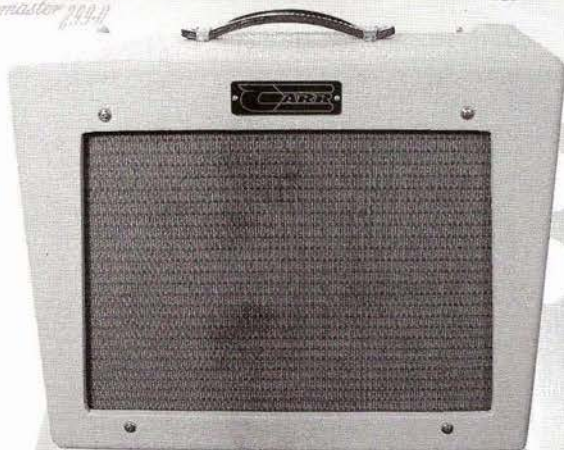

**Compactrons**

**Tubes for the Space Age**

Display until September 30, 2004



Visit us on the web [www.vacuumtube.com](http://www.vacuumtube.com)

# GLOWING REVIEWS



*"...Need a tube to go with? You can buy a nice tetrode from SED that delivers 8x as much suds, and pocket the extra change..."*

— Richard Measures



*"This tube was loud and powerful sounding with lots of headroom. In the distorted mode, it was full-bodied, with a nice, chimy response. The SV6L6GC is a solid and reliable tube for most guitar amp applications."*

— Vacuum Tube Valley

THE BEST MADE POWER TUBES  
ARE AVAILABLE IN THE US AND  
CANADA, EXCLUSIVELY FROM  
PM OF AMERICA, INC.



[WWW.SED-USA.COM](http://WWW.SED-USA.COM)



1687 SHELBY OAKS DRIVE / SUITE 8 / MEMPHIS, TN 38134 / 901-388-2424 / FAX 901-388-2405

**VTV Issue 20  
Table of Contents:**

**Kimmel Parafeed SE Amp.....4**  
**7591 The Space Savers.....6**  
**Omega Speaker Review.....11**  
**NOS: "Next Online Scam"...13**  
**Sargent Rayment Story.....15**  
**Welborne DRD 2A3 Amp.....21**  
**Dumpster Compactrons.....26**  
**Designer Profile Steve Carr..26**  
**Scott 299C/LK-72 Amp.....29**

**VTV Attends VSAC 2003**

The first weekend in October led us up to Silverdale, WA to attend and display at the VSAC 2003 show. This show, the fourth one since its inception in 1997, has been the brainstorm of Dan Schmale, aka "Doc Bottlehead."

Close to 600 dedicated tube-ophiles attended the show, which included dozens of vendors from all over the world displaying their latest tube amp and speaker designs.

Also in attendance were Ben Reginato (Bay Area Tube Club), John Atwood (former VTV Tech Editor), and Lynn Olson (VTV Tech Editor).

The complete show report is online and includes photos, links and more at [www.vacuumtube.com](http://www.vacuumtube.com) under the **VSAC2003 Report** link.

**Rocky Mountain AudioFest**

Rocky Mountain AudioFest, in conjunction with the Colorado Audio Society, is proud to announce a major three-day event. This event will be held in Denver, Colorado on October 8, 9 and 10, 2004 at the Denver Marriott Tech Center.

RMAF is a unique opportunity for audiophiles in the Rocky Mountain region and surrounding areas to see and hear the latest in audio gear. Exhibit rooms, suites and conference rooms will be packed with equipment from around the world waiting for your audition. Also scheduled during the event will be seminars and workshops from noted industry designers, vinyl, CD and accessory vendors, door prizes, and live entertainment throughout the weekend.

For more details, visit the RMAF website <http://www.audiofest.net>

**New Book on Paul Klipsch**

A new book on Paul Klipsch has just been published. **Paul Wilbur Klipsch-The Life...The Legend**, by Maureen Barrett and Michael Klementovich, is an excellent historical and biographical account of the legendary speaker designer. The book has 12 chapters covering the early beginnings, the war years, early patents, the speaker years, Paul's private side, and more. The book is profusely illustrated with lots of early photos, diagrams and illustrations previously not published. \$24.95 Rutledge Books, Inc. Danbury, CT 06811, 1-800-278-8533, [www.rutledgebooks.com](http://www.rutledgebooks.com)

**Welcome Back John Atwood!**

After a hiatus of two issues, our former Technical Editor, John Atwood has returned as a Contributing Editor to VTV. John is still very active in the tube world as a circuit designer and mentor to other designers and enthusiasts. He served as Tech Editor from Issue 1 through Issue 17.

John's famous "*Tube Dumpster*" column is back with a fascinating article on a serious Dumpster tube, the Compactron. Don't miss this article and more to come from John in future issues.

**New Book on Quad by Ken Kessler**

Ken Kessler, Senior Contributing Editor to UK's Hi-Fi News has written a new book on the history of Quad. Entitled, **Quad: The Closest Approach**.

Ken has gathered together contributions from Quad authorities from around the world. The articles and reminiscences tell the story of Quad from its pre-WWI roots to the present, along with interviews of the company's former management. It includes photos and specs of every Quad product as well.

[KSQUARE@compuserve.com](mailto:KSQUARE@compuserve.com)

**Contest for High Fidelity Part 3**

Due to time constraints and space requirements, Scott Frankland's **Contest for High Fidelity Part 3** is not in this issue. It will be featured in VTV issue #21, along with several other interesting articles.

**Editorial Staff**

- Charles Kittleson** Editor and Publisher
- Eric Barbour** Senior Editor
- Lynn Olson** Technical Editor
- John Atwood** Contributing Editor
- David Bardes** Associate Editor
- Steve Parr** Art Director
- Julie P. Werner** Copy Editor

Visit us on the web!  
[www.vacuumtube.com](http://www.vacuumtube.com)

**Vacuum Tube Valley**® is published quarterly for electronic enthusiasts interested in the colorful past, present and future of vacuum tube electronics.

Subscriptions: US\$45/4 issues 3rd Class-\$55 1st Class; Canada/\$60; Asia/\$75; Europe/\$70

**US Bank Check, Credit Cards or Cash are accepted for payment.**

**Phone (707) 263 - 5881  
FAX (707) 263 - 7648**

Copyright 2003 **Vacuum Tube Valley**®  
All rights reserved.

No part of this publication may be reprinted or electronically reproduced without written permission of the publisher.

Send circulation and editorial correspondence to:

**Vacuum Tube Valley**  
P.O. Box 1499,  
Lakeport, CA 95453 USA  
e-mail [triode@vacuumtube.com](mailto:triode@vacuumtube.com)

**ISSN # 1095-4805**

# The Choke Assisted MU Stage and the Kimmel SE Parafeed Amplifier

By Alan Kimmel ©2003 All Rights Reserved

The main feature of this amplifier is the first stage, which is my mu stage, with a little twist. Soon after I wrote my original Mu Stage article in *Glass Audio* 2/93, I found that I could substitute a two-terminal constant current source (CCS) in place of the bottom tube's plate resistor. I tried all kinds of things in place of that resistor: a JFET, a MOSFET; they worked well in that spot. In fact you can put almost anything in: an inductor, a FET, etc. These can each act as a CCS, augmenting the constant current action of the mu stage.

Of course the mu stage doesn't need a CCS there, as the mu stage effectively converts the bottom tube's plate resistor into a CCS. In 1997 it occurred to me that if bootstrapping the plate resistor via the mu stage improves the sound and performance as it does, what would happen if I replaced the plate resistor with a choke? After all, a choke is a naturally constant current device. If there could be a way to make the mu stage and a choke BETTER THAN EITHER COULD BE ALONE...

It turns out the mu stage and the choke were made for each other. Even though I call it a "Choke Assisted Mu Stage" (CAMUS), in reality it is mostly the mu stage assisting the choke.

Some will complain that inductors and transformers ring and produce other distortions. It turns out that the distortions produced by inductors are distortions that the human ear all but ignores. Even ringing, unless severe, is ignored by the human ear. In fact, the distortions that the human ear IS sensitive to happen to be distortions that well

designed and well made inductors and transformers produce very little of.

I like to use a battery (Bk1) to cathode-bias V1 but you can use a resistor in place of Bk1, or a resistor bypassed by a capacitor, or diodes, or a diode tube, or a diode-strapped triode, etc., or any suitable thing that strikes your fancy, the same as with any common-cathode stage. (Note: LEDs will work for this purpose too but LEDs can generate HF noise, so I avoid them.)

Also note that in Fig. 1 a capacitor goes from V2's cathode to the core and frame of the choke. This minimizes the core-to-winding capacitance which in turn permits maximum high frequency response. The resistor from ground to the core keeps the choke frame at DC ground. For this capacitor I would use 0.47uF/630V, and for the resistor I would use any value from 4.7 Meg to 10 Megohms. This requires electrical isolation of the choke frame from the chassis for best HF performance.

A small value choke can be used in the CAMUS because its inductance gets multiplied by the pentode cathode follower (CF) of the mu stage. The low DCR of the small choke is just right for dropping the small DC voltage necessary to bias a pentode CF. Although a triode CF could work: (A) a triode CF won't multiply the inductance of a choke as much as a pentode CF will, and (B) you would probably have to add a resistor in series with the choke to drop enough voltage to properly bias a triode CF. The small DCR of the choke alone is plenty to bias a pentode CF, which is a natural for this circuit. In the CAMUS I have used as little as 8 Henries to good effect, and I could no doubt use even less inductance. (If the choke value gets too small the bass frequencies may be attenuated somewhat.)

Instead of a mu stage, why not use just a high value choke alone, such as an anode choke? It works,

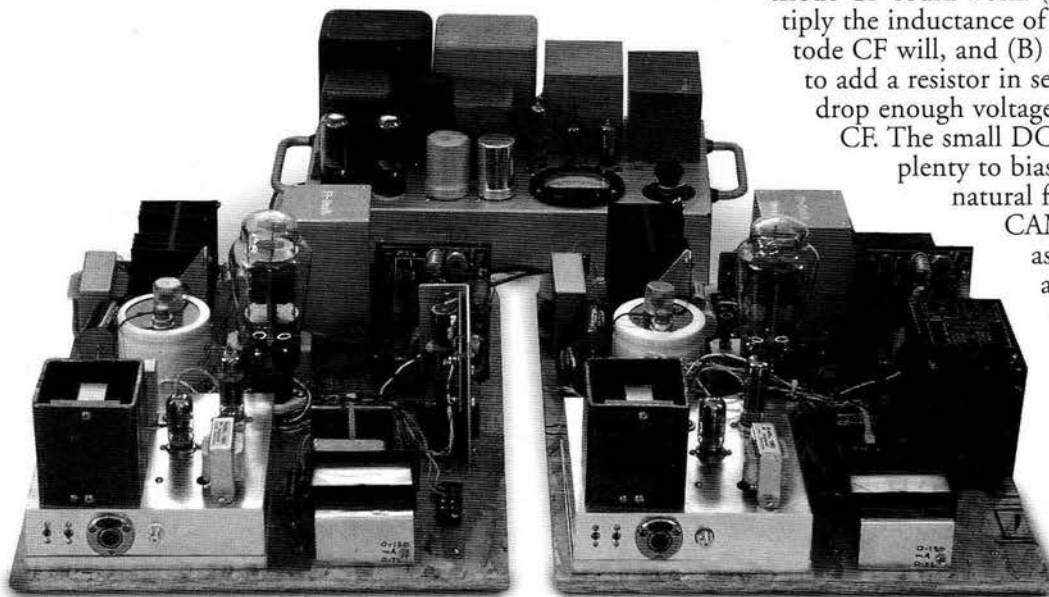

but there are limitations: for example, the relatively high impedance plate must drive the high interwinding capacitance of such a choke, limiting the bandwidth (BW). Plus there is the fact that the plate of the gain tube would be the output, and its driving ability will be more limited than that of a cathode follower output, which you have with my mu stage. And of course there is the large physical size of a plate choke.

Comparing a stage with a high value anode choke against the CAMUS:

	Pros	Cons
<b>High Value choke</b>	High Z load for voltage gain tube	Higher Interwinding capacitance = limited BW Large Size Relatively high output Z Voltage-amplifying tube must operate at high current to have good BW or good drive capability.
<b>Low value choke with mu stage</b>	High Z load for voltage gain tube Low Interwinding capacitance = wide BW Whatever small interwinding capacitance is there is virtually 100% neutralized. Small Size Low Output Z	

**Single-Ended Parafeed Amplifier:**

In the SE amplifier (Fig. 2) that John Atwood built to my specifications for this year's Bay Area Tube Fest, he used a VV320B for output tube V3. (His comments follow below.) I wanted this amp to have a parafeed output stage because of the Power Supply Rejection parafeed offers. This output stage effectively has only 3 parts in the output loop: V3, T2, and the parafeed coupling capacitor. Constant current sink IC1 keeps the DC current through the output stage constant regardless of changing or retubing V3, or the aging of V3. V1 and V3 get DC for their heaters, and V2's heater is getting AC.

Note that the case and frame of the 50H plate choke is connected to the cathode of V2. As in Fig. 1, this improves BW by eliminating the coil-to-core capacitance that would otherwise load V1 at HF. The core of the plate choke must be electrically isolated from ground for this to work. To avoid a shock hazard, the choke should also be isolated from the outside world by covering it with a non-conductive material or enclosure.

An input transformer was used so that the driver circuit could be made with no coupling capacitors. Input transformer T1 in the prototype is a Jensen JT-123-BLCF connected 1:1. This xfmr was chosen for its outstanding performance and very low distortion. Its HF performance is extraordinary in the 1:1 configuration.

Ideally the input xfmr should be enclosed in a mu metal can to suppress hum pickup, and should be mounted as far away from any power xfmr's as possible. At 1 kHz I measured this xfmr's input Z to be over 10K ohms. At low frequencies its input Z drops quite a bit; at 20 Hz the input Z is quite low; to utilize it properly at such low frequencies requires a very low source Z. (No passive preamps or volume controls ahead of T1.)

You may therefore want to use this amp only for mid and high frequencies, though it will work fine full range if you can properly drive this input xfmr at LF. Or you can use some other transformer such as Jensen's JT-11P-1, though it has somewhat reduced (but still very good) performance. Another option, suggested by Ben Reginato, is to use a Stevens & Billington transformer potentiometer for T1, and this would be the main volume control for your system. (Best option.)

It is possible to float the appropriate supplies and ground what is now the -V<sub>kk</sub> supply. This modification would eliminate the need for T1, making it possible for the amp to have a very high input impedance at all frequencies.

Note that V2, the driver tube, is a cathode follower as in my original mu stage, except that in Fig. 2 this CF has a choke (the 300H choke in the schematic) as its cathode load rather than a fixed resistor. In a plate-loaded stage where only a plate choke is the load, the tube plate provides pulldown, i.e., negative drive, while the choke acts as a reactive pull-up device. In my stage, the CF provides pull-up/positive drive, while the cathode choke provides reactive pulldown, i.e., negative output drive. I think this is important because it helps to turn off the grid of V3 as the output of V2 goes negative.

You can think of the cathode choke as a built-in grid choke for V3. Thus, fast and firm turn-on of V3's grid is provided by the CF while complementary turn-off is provided by the cathode choke. By the way, a suitable depletion mode power FET can be used in place of the CF.

There are still a few people who feel that cathode followers don't belong in audio. One thing I've noticed is that the amplifiers that continually get the best reviews also happen to have CFs. When someone badmouths CFs, they reveal that they either don't know how to design CFs correctly, and/or they don't know how to correctly apply CFs. CFs are the most FAULTLESS of all amplifier stages when they are CORRECTLY DESIGNED and CORRECTLY APPLIED.

So how did this SE amplifier sound? Everyone I heard from said they liked it quite well. It is easy to use the CAMUS in any and every kind of amplifier, bar none.

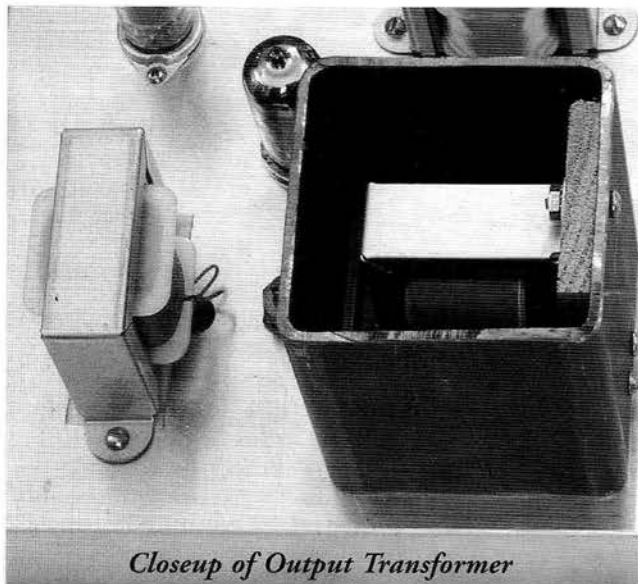

Closeup of Output Transformer

**John Atwood's comments:**

A prototype of the Kimmel SE Parafeed amplifier was built on an existing SE amplifier test bed that had been used to test earlier versions of Alan Kimmel's amps, as well as for testing output transformers. Each channel is built onto a 15" by 19" wooden board, which allows easy reconfiguration. The driver circuits were built into a metal chassis mounted on the board.

The main power supply is built on to a 8" by 15" by 3" aluminum chassis. The B+ supply is a choke-input type using two damper tube rectifiers. After the first choke/capacitor stage, two separate chokes feed B+ to each channel, ensuring good isolation between each channel as well as low hum on the power supply.

The output transformer is a Fi-Sonik OP-03058 3K ohm to 8 ohm 50% nickel-alloy transformer used in a shunt-feed configuration, with a One Electron PRC-1 choke. This combination is my favorite, based on listening tests. All tests were done with an idle current of 115 mA on the output tube. This is twice the rating of a 300B, but was well within the ratings of the VV-320B used in these tests.

All the various audio chokes and audio transformers made me nervous about hum pickup. Testing showed that only the input transformer contributed any significant hum while on the test bench. It was found that by enclosing the input xfmr in a piece of 3" by 3" steel tubing, 1/8" thick, the hum was reduced by about 7 dB.

The tests were done using an Audio Precision System Two Cascade. The output was measured across a non-inductive 8 ohm dummy load. The generator output of the Audio Precision has selectable output impedances of either 20 ohms or 600 ohms. All tests were made using the unbalanced input of the amplifier, however the balanced input of the amplifier gave very similar results.

Frequency response tests were done for both the entire amplifier, and for the driver stage only. Two things became clear when analyzing the frequency response: (1) the driver stage bandwidth far exceeds the bandwidth of the output stage, and (2) the driving impedance at the amplifier input jack has a big effect on the low frequency response. When the driver stage is loaded with just the load of the analyzer (which is roughly the same as the Miller-effect capacitance of the output tube), the response is essentially flat over the entire range of the Audio Precision (10 Hz to 200 kHz), when the Audio Precision's output impedance was set for 20 ohms. This is outstanding for a SE driver stage. The high frequency rolloff of the entire amplifier is dominated by the output transformer/shunt-feed choke combination, which is -1 dB at 65 kHz -- still pretty good for a SE amplifier.

The low frequency response was more problematic.

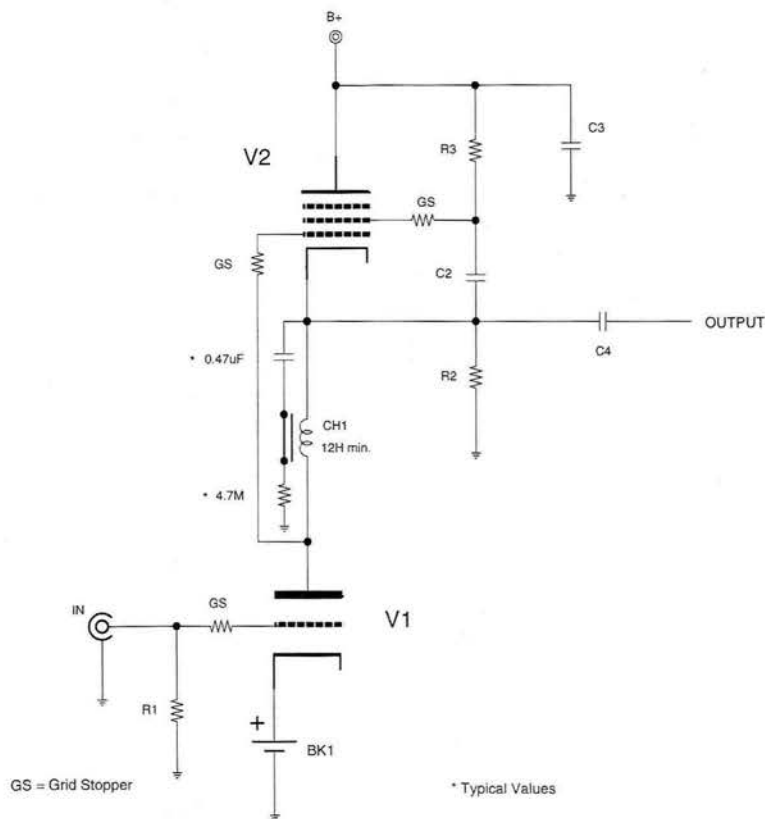
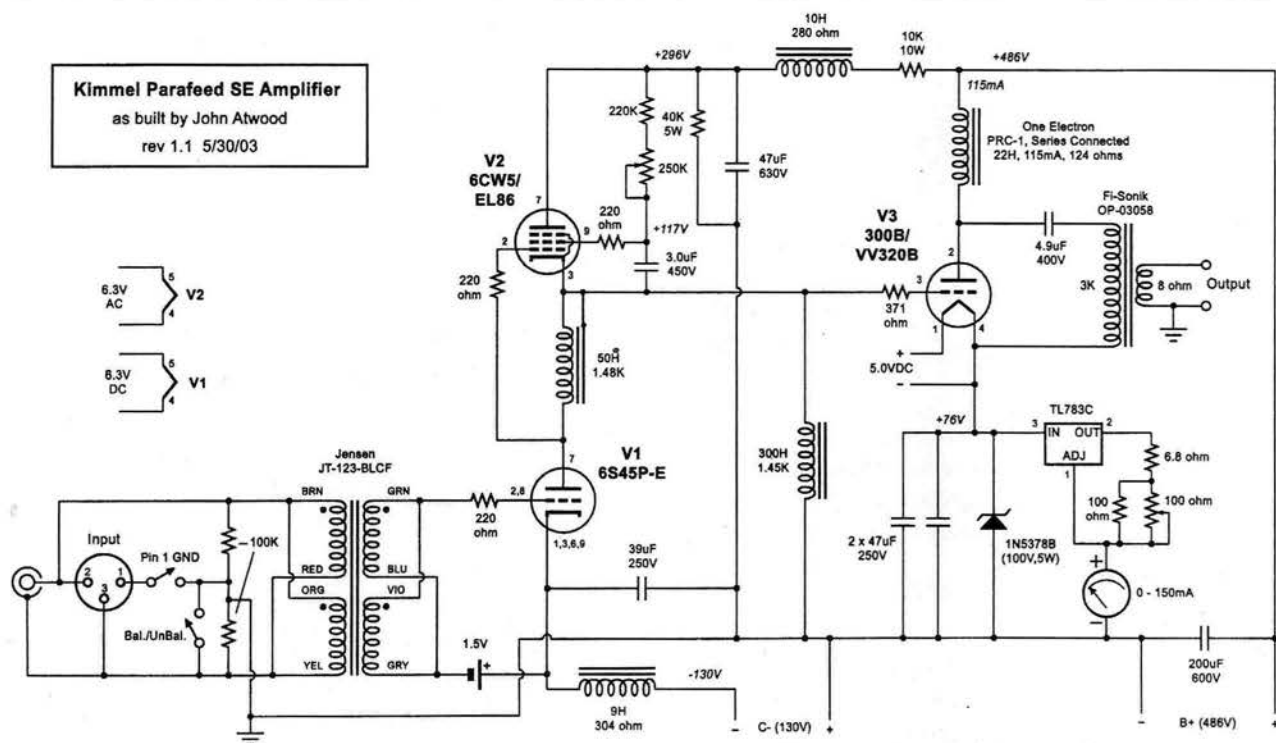

Figure 1 Kimmel Amp Schematic



**Kimmel Parafeed SE Amplifier**  
as built by John Atwood  
rev 1.1 5/30/03

**Figure 2 Kimmel Amp Schematic**

The Jensen JT-123-BLCF transformer was originally designed as a line output transformer to be driven by an op-amp with nearly zero output impedance. When the Audio Precision generator is set to 20 ohm output impedance, the low frequency response is essentially FLAT. However, with the generator set to 600 ohm output impedance, the response is -1 dB at 40 Hz. This means the amplifier is very sensitive to what it is driving it. A solid-state or high-feedback tube line stage, or even worse, a "passive preamp" (i.e., potentiometer) could be detrimental to the low frequency response. This behavior could be reduced by using a different type of input transformer, but all transformers have frequency responses that are affected by drive impedance.

At moderate power levels the strength of the first several harmonics fall uniformly (you can draw almost a straight line from the peaks of the 2nd, 3rd, and 4th harmonics). This is a hallmark of good-sounding amps, and is the most likely reason why the driver circuit sounds so good. (Fig. 3, 4)

This amplifier clips at about 16 Watts output -- the exact amount depending on the output tube and B+ voltage. For 10 Watts output, a drive of 1.48 volts rms(at 1 kHz) is required.

Overall the amplifier works extremely well. The key highlights of the driver stage are: (1) very wide bandwidth, (2) low distortion, and (3) relatively simple, plus it accepts balanced or unbalanced input. The only major

problem is the sensitivity to source impedance at the input jack. A TVC offers a good solution to this. The auto-bias circuit for the output stage works very well, as it eliminates the hassle of bias adjustment and drift.

The distortion and frequency response of the amplifier are dominated by the amp's output stage. Alan's driver stage gets completely out of the way, so that you hear only the output stage of the amp.

Listening to music: this amplifier is very good. I would give it the following characteristics: clean, lots of detail, smooth, balanced bass and treble extension, and relaxed.

**NOTES:**

Fig. 1 shows V2's suppressor grid (G3) not connected to anything, but G3 is usually internally connected to the cathode. If you use a pentode that brings its G3 out to a separate pin, connect that pin to the cathode.

Regardless of what kind of circuit you build, whether mine or someone else's design, grid stopper (GS) resistors should always be included to suppress possible parasitics. High gm tubes and power FETs especially need GS resistors. High gm devices like to oscillate; don't provoke them by omitting the GS resistors. Without the GS resistor they could oscillate at some VHF frequency which may manifest itself only as a haze or smear to the sound. GS resistors should be placed as close as possible to the grid or gate.

# 7591 - The Space Savers

By Eric Barbour ©2003 All Rights Reserved

RCA and Western Electric deserved the fame they are known for, but the dazzle generated by the Big Two of audio obscures other tube manufacturers. One of these obscure tube manufacturers was Westinghouse.

Westinghouse was one of the largest manufacturers, developers and distributors of receiving tubes in America. One recently-discovered example was a copy of "Dave Rice's Official Pricing Digest for Radio and Television Servicemen," from 1960. It revealed that while RCA was offering 604 different types of receiving tubes for sale to servicemen, and GE offered 627 types, Westinghouse was offering 992 types. Admittedly, many of each firm's tubes were sourced from other firms and relabeled, a practice still going on today. Still, the general idea is that Westinghouse was a major OEM or source for receiving tubes. Yet I've never seen an article in MJ on the special magic in a Westinghouse product. In fact, legend has it that Westinghouse was one of the first companies to start importing Japanese tubes for the service market. At the time, they were claiming better quality at a lower price!

An excellent example of Westinghouses' invisibility is the 7591. Introduced in 1958 and registered with EIA in February 1960, it has hardly been written about in ANY vintage electronics publications. Neither were its imitators, the RCA 7868 or the Sylvania 6GM5, yet this was one of the most popular high-fidelity tubes ever made. Uncounted millions of stereo receivers and integrated amps were made by Fisher, Scott, Sherwood, Pilot, Sansui, Kenwood, Pioneer and other firms to use

the 7591. We think that 7591 was developed and produced at Westinghouse's Bath, NY receiving tube factory.

Intended for home audio amps, the original 7591 was a physically short, high-efficiency beam tetrode that looks as though it was meant to steal some business away from the 6L6GC and EL34/6CA7. The dissipation was 19 watts, adequate for two tubes to produce a claimed 45 watts in pentode AB1 operation push-pull (by running the tubes right at their limits). The drive characteristics were similar to those of the 6550, allowing simple driver circuitry to save money. Researching the original ratings is complicated by the fact that

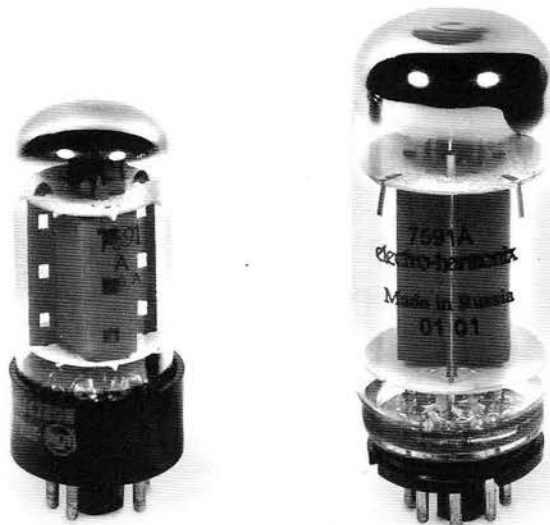

RCA 7591A and Electro-Harmonix 7591A EH

Westinghouse didn't really publish a tube manual, nor did they widely disseminate data for their in-house products.

It wasn't invented at RCA, but RCA submitted to the inevitable and added the 7591 (bought in from Westinghouse at first) to their replacement line in

November 1961. Most other firms followed suit, in spite of the tube's low cost (thus, low profit margin). We have a 1969 GE retail price list for distributors; it shows a price of \$8.45 for the 6L6GC and \$12.85 for the 12AX7A. In the same list, a 7591A was priced at \$2.30. Now that's aggressive discounting! I suspect that this pricing was probably just above the production cost. These tubes were considered purely "entertainment" types, and there

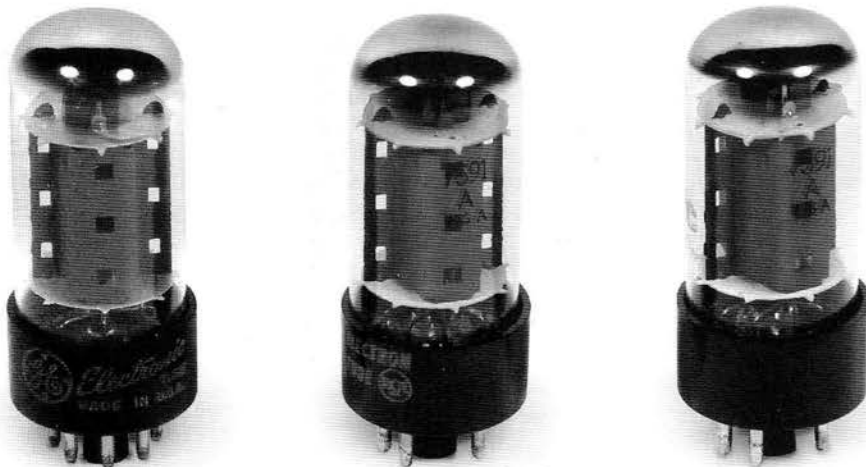

GE 7591A, RCA 7591A and Sylvania 7591A



was no effort to offer them to the profitable military market. This would explain the lack of a MIL-E-1 specification for any of them.

By April 1963, the OEMs were asking for better specs, so the 7591A version appeared. As far as we can tell, only the zero-bias plate and screen currents were "controlled," mainly by improving screen dissipation, and a low-loss base was added. The Westinghouse data sheet claims "screen dissipation may be permitted to reach 6 watts during the maximum input of speech and music signals." How daring and optimistic! At the same time, grid-resistor maximums were pushed up to 0.3 megohms in fixed bias and a dangerous 1 megohm in cathode bias. Thus, we have all those Fisher 500C receivers, running their 7591As at 430v plate and screen, with 330K grid resistors--right at the limit of what a reasonable designer would try to do, especially with something the size of a 6V6. The A version must have been extremely popular at the beginning, because RCA added it in June 1964, even though internal RCA records indicated shortages in the supply.

The 7591 was very popular in hi-fi receivers and integrators. Some of these included the EICO ST40, ST70, 2050, and 2080; Fisher X-101C, X-202B and C, 500B and C and 800A-C; Harman-Kardon 7000; Heathkit 151; Madison-Fielding amps; McIntosh MC225, MA230 and 1500; Pilot 540 and 264; Scott 299C, 299D, LK-72, 340, 340B and 208; and the late-model Sherwood 5000 series. Many lesser brands depended on the 7591. It also found its way into guitar amps made by Ampeg, Gibson and Univox. Rockola jukeboxes from the early stereo period used 7591s in their amp section. Even Hammond made an organ amplifier using 7591s, for the rare E-200 series of the late 1960s.

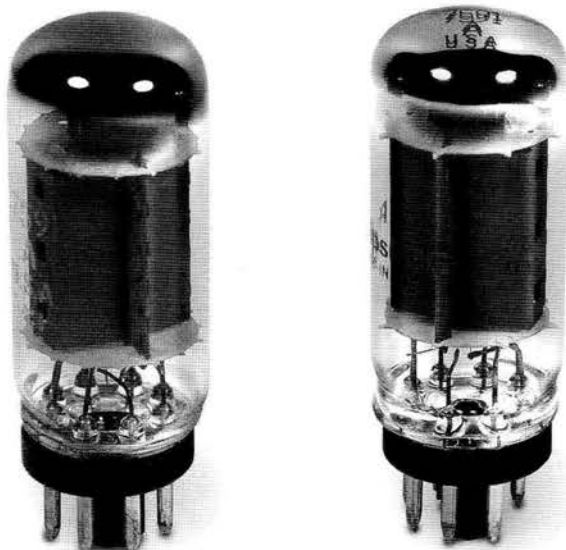

*Button Base GE 7591A and Philips 7591A*

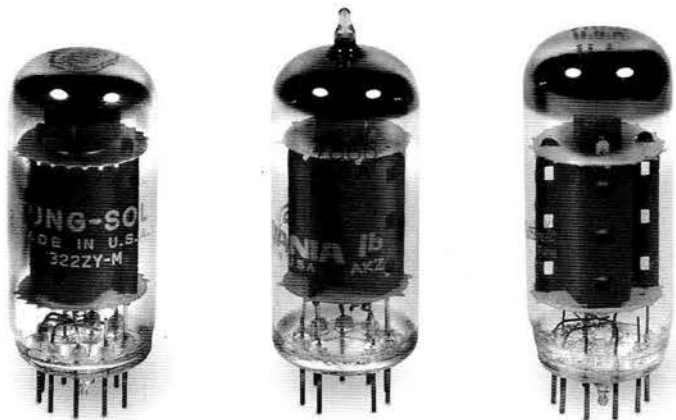

*Tung-Sol 7868, Sylvania 7868 and GE 7868*

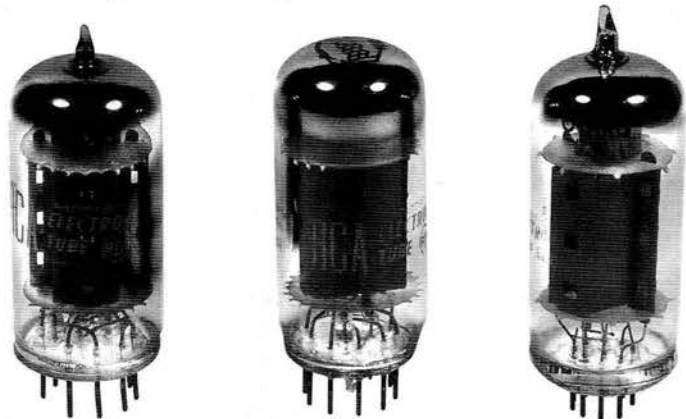

*RCA 7868 Black Plate (tip), RCA 7868 and RCA 6GM5*

By the way, one should be VERY careful looking at websites edited by musicians. Often there is no independent oversight, thus freeing site owners to write all kinds of inane drivel. Good examples were found at [www.harmpamps.com](http://www.harmpamps.com): "EL84's or 7591 tubes are roughly the same as a 6L6 in a different package" is absolutely not true. Neither is "early tube amps used 6SN7 or 6SJ7 instead of this tube. These are nice tubes, but are not as powerful...as the 12AX7 type tubes." If this guy would stick to the SOUND of the different circuits, he'd have no problems.

Soon after its appearance, Sylvania was making their own 7591. GE followed suit sometime in the mid-1960s. Matsushita and Hitachi were also known to make 7591As, which are very similar in many ratings to their 25E5 sweep tube. The popular Sansui 1000 receiver originally used 25E5s and switched to 7591As later. Other brands of Japanese stereo amplifiers and receivers were similar. Westinghouse probably stopped making the 7591A circa 1970, switching to Japanese production for the service market. GE continued production into the 1980s. Circa 1968, GE switched its 7591A production from the large octal base to a small wafer-like base--similar to their 6SN7 production at the time. These tubes are generally thought to be inferior to the earlier large-base versions.

It was inevitable that other firms would try to poach some 7591 business with their own, incompatible versions. RCA was pushing the "Novar" base in the late '50s, so they introduced the 7868 in November 1960. Except for the Novar base, it was virtually identical to the 7591. RCA even tried to take a patent out on some aspect of this tube.

We actually have more info about the 7868, thanks to Lud Sibley, Bro. Patrick Dowd and the RCA Archive. An RCA sales projection optimistically predicted sales of 300,000 in the first year "at expense of 6L6GC and 7027A." It is doubtful if sales ever reached this level.

The original version had a top tip and top getter, while in 1964 the tip was moved to the bottom, most Novar sockets having a large hole in the middle. Side getter was added in 1962, and screen-grid radiators (always a good idea for an audio tetrode rated for ultra-linear connection) were added in 1967. The 7868 found some commercial success--it was used in the popular Fisher 400 receiver and X-101B amplifier, some Sherwood 7000 and 8000 receivers, as well as jukebox amplifiers made by Rockola and Rowe-AMI. Rumor has it that production of these jukeboxes continued well into the 1970s, when RCA stopped making 7868s. See "jukebox-guide.com" for more information.

Examining the RCA archive revealed two interesting facts. One is that the 7868 had its grid construction revised several times during the 1960s. Wire diameter changed from 2.0 mil to 3.0, then to 2.8; and the turns per inch decreased from 64 to 55. And even more revealing, RCA simply took the cathode from their 6BQ5 of the period, and used it unmodified in the 7868. So, the 7868 is basically an aligned-grid 6BQ5 with bigger plate and envelope.

Sylvania performed similar acrobatics, in the process of trying to foist their "9-T9" tube base upon the world. This base was just a 9-pin miniature, having a larger button diameter to accommodate power tubes and complex TV multi-unit types. The 6GM5 was registered in March 1961. And yes, except for its base, it was virtually identical to the 7591 electrically. Unlike the 7868, the 6GM5 found very little market space.

Luckily (?) for us, GE didn't try to make a similar tube in their duodecar Compactron base. (Or did they? GE produced thousands of experimental types over the years. Unfortunately, most of GE's receiving tube archive has been discarded.)

*Note from Tech Editor: The 7591 and 7868 were introduced right at the very end of the vacuum tube era. Transistors swept away almost all tube hi-fi by 1966-68.*

## TESTS

Please bear in mind that these figures were run long before the "Sovtek" 7591A was offered to the public.

## TESTS OF AMERICAN 7591s

All were tested at 500v plate, 300v screen, 50 mA, plate load of 3200 ohms. All were tested for second-harmonic distortion at 1 watt output at 1000 Hz.

\*=good used tube, others NOS in original boxes.

Version	Distortion	Peak out	At bias
Syl large base*	.75 %	10.0vrms	11.0vdc
Syl large base*	.87	11.0	-11.4
Scott brand large base*	.87	10.5	-11.1
Westinghouse lg base*	.90	10.5	-10.7
Syl large base*	.90	10.5	-11.3
Scott brand large base*	.90	11.0	-10.5
Syl large base*	.92	9.5	-10.5
Scott brand large base*	.95	11.0	-11.0
RCA small base*	1.05	10.5	-10.5
RCA small base*	1.10	11.0	-10.9
Syl small base*	1.10	11.0	-11.0
Syl large base	1.10	10.5	-11.9
GE large base 1963	1.10	10.0	-11.4
GE large base 70s	1.12	11.0	-12.0
Syl small base	1.15	11.0	-10.9
GE small base	1.15	11.5	-12.3
RCA large base*	1.17	11.0	-12.0
Syl small base	1.17	10.5	-12.2
Syl small base	1.17	10.5	-11.0
Syl small base	1.17	10.5	-11.0
GE small base	1.17	11.5	-13.7
Syl small base	1.20	11.5	-12.5
RCA large base 60s	1.20	12.0	-13.9
RCA large base	1.20	11.5	-12.5
RCA large base	1.20	11.5	-13.0

## ACKNOWLEDGEMENTS

*My sincere thanks to Ludwell Sibley of the Tube Collector's Association for his invaluable help with this difficult research area, and to the AWA Museum for providing RCA research data. Also thanks to John Atwood for his help with the archive data.*

# Omega Speaker Systems Super, Super 8

By David Bardes ©2003 All Rights Reserved

“Keep it simple stupid” is a watch phrase for a lot of tube-o-philos. Simple circuits and a low parts count go a long way to clearing up the electronic clutter between musician and music fan. This approach has been applied to loudspeakers where single, full-range drivers are currently enjoying a renaissance. Type in “full-range” in eBay’s browser and see how many people are buying and selling those vintage oval radio speakers, and be amazed by how much they are trading for. What’s going on here?

Full-range driver sound can be very expensive or it can be done on a budget. Lowther and Jordan drivers can cost more than many complete speaker systems and they often require elaborate enclosures to make them sound their best. On the other hand, relatively inexpensive vintage drivers are being mounted on large open baffles to satisfy the full-range cravings of DIYers. Whichever path they take, there is a growing group of avid (and sometimes rabid) full-range driver fans.

One recent convert is Louis Chochos, owner and creator of Omega Speaker Systems. He found his calling when he discovered Fostex full-range drivers and immediately abandoned his line of 86 db two-way “cat coffin” loudspeakers. Instead of yet another bookshelf two-way speaker, Louis has launched a line of Fostex driven, moderately priced loudspeakers.

My review sample of the Super 8 uses the larger 8” Fostex driver and is finished in a gorgeous sepele wood veneer. This is a good looking speaker! Louis has many finishes available, but the sepele veneer and the arctic blue laminate seem to be the most popular. Unlike many of today’s speaker offerings, the driver is mounted on the wide side of the enclosure, which Louis says makes for a smoother sound. The speaker has two ports located beneath the driver, and a set of metal binding posts in the rear (only ONE set, nope, no biamping here). The cabinet is VERY solid, heavy and well damped. The speakers are rated at 96 db efficiency and are an easy-to-drive 8 ohms.

My speakers arrived with very explicit instructions for a 100 hour break-in period before any critical listening is performed. This is what I do for all speakers that arrive for review, but these speakers really transform from a closed-in, “why did I buy these speakers?” sound to an open relaxed sound after the break in period. I understand that this is typical for full-range drivers, and that if you’re not willing to wait until these

speakers are fully broken in, you will be disappointed. In fact, 100 hours is a minimum, as the speakers continue to break in, the sound gets better and better.

The other caveat for this class of speakers is the use of high-definition speaker cable.

Thick stranded speaker cable will make these speakers bloated and smear the fine detail they are capable of delivering.

With these caveats in mind, I set out to see what these speakers were capable of. Placed on Skylan sand-filled stands designed for the Super 8 (These are very nice, metal-free, 4 post stands), I first placed them in my living room as I would other stand-mount speakers, about 3 feet from the back wall, about 10 feet apart and with a moderate degree of toe-in. What I heard was a large open sound stage, and a coherency and speed that are the hallmarks of single driver cross-over-less speakers. My first impression was that this speaker has a smoother frequency response than I remember Lowther speakers having. A little more bass response, less speed, and gratefully none of the papery mid-range zing than I remember with the Lowther drivers. The Super 8s were efficient enough to easily accommodate low wattage 2A3 amps and could really jam with my 300B amp.

The Omega Super 8s possess a harmonic richness that made pianos, guitars, and brass sound amazingly lifelike. John Hicks’ piano on the Mapleshade recording of “The Wandering Soul,” on *John Hicks, Trio + Strings* was the most lifelike piano I have ever heard in my living room. I realized that as I was listening, that maybe



part of the magic might be the absence of any signal surgery after the DAC in the CD player. From a recording that was recorded straight from microphone to tape, without the use of mixers, compressors etc., to the playback system that doesn't use any feedback or signal splitting in the amp or in the speaker, to the use of solid core cabling throughout, this great sound is a strong case for the KISS paradigm.

Other recordings were equally convincing as with Carol Welsman's recording of "Taking a Chance on Love." (*Jazz for the Open Road*, Savoy Jazz) Here the female vocal was clear and convincing and the supporting instruments were clearly defined and placed in the sound stage. Again I was struck by the harmonic richness in the music. The music was also dynamic and full, including the inner dynamics that are a result of low level musical detail shining through.

The Super 8s don't have the startle factor that super fast speakers possess. They have good speed, better than many multi-way speakers, but they don't compare to electrostatic speakers or other full-range drivers. I understand that the smaller Fostex drivers are faster and convey some of that electrostatic speed. Still, treble detail is very good and sounds quite smooth and extended despite what appears on the Fostex response graphs. Bells, cymbals and the like are clear and without sibilance, and the decay is natural and convincing. I thought the Super 8s would beam more than they do. The treble is directional, but I've heard more severe beaming and from multi-way systems too.

The Super 8s push enough air to make drums, especially kick-drums, have real impact. A pet peeve of mine is smallish speakers that go "pphht" when they should be sounding like a kick-drum. Unfortunately, the Super 8's are just a bit shy when it comes to bass extension. As I was listening, I kept wishing for just a bit more volume from the bass line. The Super 8s get the most out of the Fostex driver, but any affordable driver can't be efficient, do a super job in the treble, AND dig down deep for the bass. The bass is there, clean and well behaved, just a bit recessed. If you are a bass fan, you'll need to find a fast and clean subwoofer to compliment the excellent music reproduction of the Super 8.

I tried moving the speakers closer to the listening position, between 4 and 5 feet. At this distance the Super 8s sounded more dynamic and the sound stage was even deeper and more convincing. The bass seemed better at this distance too. At 5 feet, the Super 8s need only as much power as my Khorns require placed across the room. In short, these speakers make great near-field monitors. And I can imagine sitting on one of those cool Eames lounge chairs with my feet on the matching footstool listening to the Super 8s on the Skylan stands placed near by.

The Super 8s by Omega Speaker Systems are beautiful

to look at and to listen to. They are easy to drive and are efficient for your favorite 2A3 or 300B amp. The Super 8s provide the harmonic richness and nimbleness that makes single driver loudspeakers so appealing. They are a great value at \$999 and don't require a lot of fuss to set up. Feed them a clean signal and you'll be rewarded with hours of listening pleasure.

### Omega Super 8

<b>Dynamic Range</b>	<b>Transparency</b>	<b>Frequency</b>	<b>Extension</b>
4.5	4.75		4

<b>Dimensionality</b>	<b>Pace &amp; Rhythm</b>	<b>Musical Involvement</b>
5	4.5	4.5

**Overall Score: 4.5**

#### Specifications:

- Frequency Response : 49-20KHz
- Impedance : 8 ohms
- Sensitivity : 96dB
- Power Handling : 90 Watts
- Minimum Amplifier : 1.5 Watts
- Twin 2" ports
- Termination : Gold plated 5-way binding posts
- Cabinet Dimensions : 16"H x 12"W x 9.5"D
- Cabinet Construction : 3/4" Softwood M. D. F. braced and adhered with polyurethane glues
- Decoupled baffle and back
- Weight : 24 pounds each
- MSRP \$999/pair

#### Test System Components:

- Jolida JD 603 CD player with Mullard CV4004 tubes in the analog output section
- Assemblage SET 300 amp with JJ 300B tubes, Welborne Labs Dynamic Reactance 2A3 amp
- Homebrew fine wire speaker cables TEK LINE PC -12 Signature power cords for both the amp and CD player
- Nordost Blue Heaven and VSE Super Clear interconnects
- Skylan speaker stands

#### Omega Speaker Systems

327 Main Avenue  
 Norwalk Ct. 06851  
 Phone: 203-847-2800 Fax: 203-847-4797  
[marathonspeakers@juno.com](mailto:marathonspeakers@juno.com)

# "NOS" - Next Online Scam?

By Eric Barbour ©2003 All Rights Reserved

VTV has already discussed the rise of the NOS tube as a collectible, whose price rises faster than leading economic indicators. However, we still need to look into the place where such NOS material is routinely traded--online auction websites.

Most of the NOS claims in online auctions appear to be made by inexperienced sellers. Indeed, the vast popularity of online auctions seems to be a phenomenon of working-class origins, involving people who are not experts in a given collecting field, trying to get top dollar for their dubious finds. A situation like this is ideal for counterfeiting, especially if done third-hand. Lack of sophistication is a hallmark of the dedicated online auction seller. Indeed, eBay seems to have developed a fan base of almost religious fervor and aggression. After looking at hundreds of online auctions I can say safely that item descriptions would be more effective if they were not written in capitals and were spell-checked before submission--but that's only the beginning of the problems.

Recent online auctions that appear to involve mislabeled tubes include 3035584029, a set of low-cost Russian 6P3S's marked "6L6GC" and packaged in glossy reprinted RCA brand boxes. The tubes bore "made in Gt. Britain" labeling, an impossibility which any experienced tube dealer or hi-fi collector would recognize immediately as fraud. The mislabeling was probably done by a well-known New Jersey tube distributor in the late 1980s. Nevertheless, the seller got \$140 for his tubes, and neither the buyer nor the auction site management was ever the wiser.

Another questionable auction was 2547783120, offering an ECC83M claimed to be "NOS." The tube actually pictured looks like older Chinese production, thus barely qualifying it as NOS. "ECC83M" was obviously printed on the tube by someone other than the now-defunct Chinese factory. In all probability, both these sellers obtained their tubes at flea markets or from dealers who went out of business. In our experience, many relabeled, rebranded or otherwise phony tubes were sold to TV repair shops in the 1980s. When the shop owner dies, or retires, and sells off the remaining stocks of parts, the origin of the tubes is further obscured.

Looking through current online auctions can be amusing, speaking from the perspective of someone who knows what certain tubes should sell for and what they are used for. Some online knuckleheads have seen genuine Western Electric tubes sell for outrageous prices, so they sometimes put the words "Western Electric" in the auction title, whether the tube has anything to do with Western Electric or not. The term "NOS" is wildly popular, for the same reason. (The term "NOS" is also attached to its original subject, old automotive parts, with similar abandon.) Things like 7X7s and 6AV8s have little value in the real world, yet it fails to deter the aggressive ignoramus from pumping these goods online. Sellers often assume that every tube is usable for audio, so NOS tubes are usually categorized as audio devices--even thyratrons and eye tubes! They simply want to generate bids, by any means necessary. With popular auctions sites handling millions of bid transactions each day, it's easy to get lost in the static.



*Counterfeit Telefunken 12AU7  
(No diamond on the base)*

(Speaking of static, I recently saw an online auction for "Genuine Elvis Presley Booger Preserved in Glass Jar!" which was "certified authentic." By whom, I have no idea. No photo was presented. Obviously a joke listing, yet several people apparently placed serious bids on it. And eBay has recently started removing finished auctions from its database very quickly, making research into fraudulent auction items much more difficult. The Elvis-booger auction was removed as soon as it was completed.)

And eBay is hardly the only online auction to suffer from this--Yahoo Auctions are becoming the first credible eBay competitor, yet suffers from the same problems. And judging by recent media reports, Yahoo Auctions management is even slower to investigate outright cases of fraud involving their auction system.

Don't forget that NOS tube sales are a very small income stream for online auctions. Compared to the outrageous scams foisted onto the sports-collectible world or the art scene, phony NOS tubes still barely rate a ripple in the pond. One sports-collectible dealer estimated that there were "10,000 times" as many Honus Wagner "T206" baseball cards in circulation as were actually printed in 1909--and many of them are for sale online at any given time. In June 2001, a blatantly phony Wagner card drew a \$20,000 bid on its online auction, despite being tagged a fake by experts on MSNBC. (The whole story is at <http://www.auction>

bytes.com/pages/abn/y01/m06/i14/s02.) Another Wagner card was offered on eBay in December 2002, with a reserve of \$300,000. Even experts in the field disagreed as to its authenticity. A genuine, verifiable and traceable Wagner card now sells for as much as \$1.2 million. Perhaps 50 certifiable genuine ones exist. Any discussion of such memorabilia seems to involve guys with criminal records. And unlike baseball cards, vacuum tubes are routinely used up by obsessive owners. How long before new-in-box Western Electric 252A triodes or Telefunken VF14 pentodes enjoy this kind of attention?



**Counterfeit Mullard  
12AX7**

More disturbing is the increasing level of NOS fraud by "legitimate" storefront dealers. We were recently told by a VTV reader that several of the vintage hi-fi dealers in Hong Kong have taken to selling large quantities of blatantly bogus NOS tubes. These tubes are typically Chinese, Ei, JJ or Sovtek tubes that have been rebranded as "Mullard," "RCA," "Telefunken," "Siemens" etc. A sure sign of counterfeit tubes is to look for the words "Foreign Made". Neither Amperex, Mullard, Siemens nor Telefunken ever printed that on their original tubes. A few years back, a tube dealer in Hong Kong was actually reprinting old RCA, Tung-Sol, Amperex, Telefunken, Mullard, etc. boxes and selling them to other tube dealers. These boxes are not like the original item. They are typically printed with glossy paper and ink, with fake scratches and marks on the paper to make them look old. Almost all original tube boxes were printed with flat finish inks and on matte finish paper. Buyer Beware!

Recently I rebuilt a McIntosh MX-110 tuner-preamp which contained some genuine Telefunken smooth-plate ECC83s. It also had a Telefunken ECC82 in its multiplex circuit, which the owner had "paid a lot of money for". This "Telefunken" turned out to be a relabeled Tungram. He bought all the tubes from "legit" dealers, and was quite disturbed to be told that he'd been taken.

We have a set of KT88s in very realistic-looking Gold Lion boxes--if you pass over the fact that M-OV never used this color scheme on their valve cartons. The tubes inside are obviously Liuzhou products with Genalex printing. If these were real M-OV products, they would bear the blue-and-grey Genalex water-slide decals which M-OV traditionally used on their "Gold Lion" branded items. The tubes bear no traces of such decals, thus end-

ing the argument. Yet the latest reports are that someone in the UK is making reproduction blue-and-grey Genalex water-slide decals. They have recently been offered for sale, you guessed it, online--supposedly for restoration of antique Genalex radios. (Yeah, right!) Soon the fake tubes will be almost impossible to tell from the genuine article, at least visually. We even have some fake Genalex KT77s that were actually made by Tesla. They are in fake reprint boxes, complete with reprinted performance reports and black bases.



**Real Mullard ECC88**

Our guitar amp editor, Ron Veil, reports that Mullard fakes have become extremely commonplace. Vintage-guitar specialists and unscrupulous service technicians are offering these phonies, mostly 12AX7s but also EL34 and EL84 power tubes to guitarists. It's amazing to Ron (and myself) that people are dumb enough to buy a "Mullard" 6L6GC, in spite of the well-known fact that Mullard NEVER MADE a 6L6GC. It now happens every day. Not surprisingly, the seller and the buyer are usually reluctant to talk about the transaction.

The trade continues, with persons on both sides of the transaction often ignorant of the actual source of the tubes in question. It has barely begun as an "industry." We feel safe in making one statement of certainty for the future: You will be seeing more phony NOS tubes. The KT66s and KT88s made by Liuzhou are now very realistic-looking copies of the M-OV originals, while the Full Music/Tianjin copies of Western Electric 205D and 300B triodes and 274Bs are quite convincing in appearance to the untrained eye. And Chinese makers are doubtless working on more types for future sale. With tubes so easily rebranded, and sold for huge profits, the opportunities for fraud are growing by the day.



**Real Mullard E88CC**

# The Sargent-Rayment Story

## 1927-1961

By Roger Anderson ©2003 All Rights Reserved

Although most of us who are interested in vintage audio and hi-fi equipment are familiar with the well known names that have justifiably become legendary, the Fishers, McIntoshes and Marantz of the world, there were a number of smaller innovators who designed and produced some outstanding, though lesser-known products. Some of these obscure companies were known only in certain regions or for a limited number of products that were in production for only a short time. I hope to shed some light on a company that was in business for nearly 40 years, that produced some genuine innovations in the hi-fi field, and whose products are held in very high esteem by those fortunate few who are lucky enough to own and use them today. This is the story of the Sargent-Rayment Company of Oakland, California.

Most of the information which formed the basis for this article was provided to me over the course of several interviews and from printed materials provided by Mr. Lyndon William Rayment (aka Will) the President, as well as Chief Engineer, Production Manager, and Sales Manager of the company which bears his name from 1950 to 1961.

Talk about chief cook and bottle washer! Mr. Rayment is a delightful gentleman and has been most generous to me with his time and willingness to help in providing the background information needed to document the history of the Sargent-Rayment Company. It is a fortunate turn of events, indeed, when an author can have access to the person who actually made much of the history being written about.

### Sargent-Rayment 1927-1947: Radio Origins

As a result of the tidal wave of interest in the new radio hobby which blossomed after World War I, Lyndon Charles (LC) Rayment and Edward M. (EM) Sargent, both of Oakland CA, decided in 1927 to collaborate in the servicing and production of the new radio receivers. LC had been a radio operator in the first World War and afterward repaired radios for the U.S. Navy at Mare Island CA. EM had attended Stanford around the same time, but left just several days before receiving his degree due to a serious musculo-skeletal illness which resulted in having to walk with 2 canes for

the remainder of his life. Both men were enthralled with the burgeoning radio industry, enthusiasm for which was sweeping over the country at the time, much as personal computing was to do in the early 1980s. They started a company in 1927 to build Tuned Radio Frequency (TRF) radio equipment in the basement of a radio store in Oakland CA. Soon thereafter Sargent and Rayment developed a circuit which they named the "Infradyne" circuit, which was a major success and which thereafter led to further improved versions which sold well. In 1928, a completely new Model 7 Classic Silver Marshall TRF radio receiver was introduced under the Sargent-Rayment name. This radio received a highly laudatory review in the Dec. 8

issue of Radio World, one of the leading radio amateur magazines, resulting in an extremely high regard for the SR name and acceptance in the increasingly sophisticated radio amateur community. Eventually the excellent reputation of SR products culminated in a number of U.S. Government contracts to build communication receivers and radio direction finders for military use, especially aboard U.S. Navy vessels, where they were used into the post WWII era. The company also continued to build and improve their TRF receivers, increasing their distribution

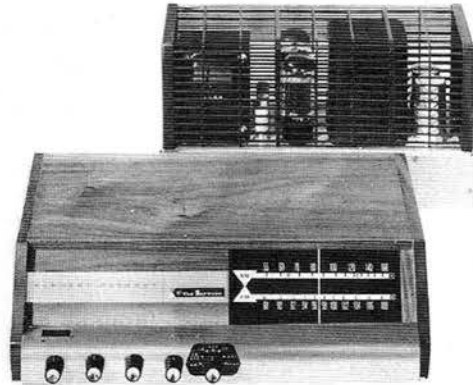

the Maywood SR-300  
In cantilevered control cabinet

throughout the US.

Although the products themselves were of unquestioned quality and reputation, the Crash of 1929 and the following Depression resulted in the cancellation of thousands of dollars of orders, and necessitated that LC depart the company, which at that time became the E.M. Sargent Company. For several years, LC designed diathermy machines for the medical market, then microphones and associated amplification equipment under the Victory Rayment name. He also designed amplifiers for Rock-Ola jukeboxes under contract to the company owner, Mr. Willard Wayne. In 1938 he returned to become the Chief Engineer for E.M. Sargent Co. under Ed Sargent, with increasing emphasis on design and production of military receivers and radio direction finders as it was becoming obvious that these would soon be required in vast quantities. During this period, the young Will Rayment worked in the summertime, helping with assembly and beginning to absorb this exciting and changing technology. Motivated by his father, he completed the course to get his FCC

license to become a radio operator. After the outbreak of the war, Will worked as Chief Radio Operator in the Merchant Marine aboard a Liberty ship in the South Pacific. In addition to becoming highly experienced in the role of radioman, Will had some rather harrowing experiences during his duty in the South Pacific, which he has subsequently written about under the pen name of Marrill Johnson (an amalgam of his and his wife's names), and wherein he recounts some of his more exciting encounters with the Japanese Navy!

During and after the war period, the E.M. Sargent Company provided large numbers of communication receivers and radio direction finders to the Navy, which sustained the company for a time after the armistice was signed, but as military contracts dwindled in the late 1940s it became clear that new avenues must be found. Meantime EM had become rather fond of "playing the ponies" and at the none too subtle urging of some shady guys with black shirts and white ties, he "decided" to sell the company to pay off his gambling debts. Now LC had the opportunity to buy the company where he had played a vital role for many years. The company now became, for the second time, the Sargent-Rayment Company, capitalizing on a reputation for quality and performance that SR products had earned over two decades. Unfortunately, LC was now in increasingly poor health, having had 2 heart attacks during the war years. It soon became increasingly obvious that Will would be playing a significant and, ultimately, primary role in the future of the Sargent-Rayment company.

After the War and 2 tours of duty on a T-2 oil tanker supplying fuel to Navy ships in the South Pacific, Will left the Merchant Marine and worked briefly as a DJ in Paso Robles CA. However, after a short time, LC asked him in 1947 to return to assist him at Sargent-Rayment

with an attempt to re-enter the communications receiver business. The huge amount of high quality WWII surplus being dumped on the market for pennies on the dollar made this all but impossible, however. After some investigation, market research, and ultimately with nowhere else to turn, LC and Will finally made the momentous decision to abandon the communications receiver field to enter the newly emerging market for what some were calling at the time "custom radios," and

others were calling "Hi-Fi." Great interest had developed with a number of discriminating individuals in obtaining audio equipment of an entirely new class of performance far above the mass-market "tombstone" table or floor radios of the 30s, and post-war manufacturers new and old were more than willing to oblige by providing radio receivers and amplifiers built to standards heretofore unseen. Avery Fisher had been in this market early on, starting in the late 1930s, and had built a reputation in the East for his fine products which were now becoming known in the West, especially in California. Other companies, such as Radio Craftsman and Pilot, had also begun to distribute their first Hi-Fi receivers and amplifiers. Will and LC figured that given the performance and reputation of their radio products of past decades, they were more

than up to the task of manufacturing products in California worthy of the label "High Fidelity." Thus the decision was made which altered the course of the Sargent-Rayment Company for the remainder of its existence.

**The Sargent-Rayment Company 1948-1955: Growing Pains**

Obviously, once the decision to take the Company in an entirely new direction had been made, a new line of products suitable for the demanding Hi-Fi market had to be quickly designed, manufactured, and marketed. In order to do this in minimum time, but still have a product that would not only be competitive but offer some-

**1956 Sargent Rayment Line**

**SR-100**  
A superb AM-FM tuner that incorporates engineering features found only in the most expensive units. Designed and priced as the ideal companion to the SR-200.

**THE OUTSTANDING FEATURES ARE:**  
\* **TWO POSITIONS OF AM**, thus allowing FM-like performance on clear channel AM stations.  
\* **BRIDGE "T" 10 KC WHISTLE FILTER**, with zero attenuation at 8 KC, -55 DB at 10 KC.  
\* **THE FAMED SR TWO TUBE AM DETECTOR**, acclaimed by leading research organizations as the only AM detector capable of delivering true high fidelity programming with only .45% harmonic distortion at 100% modulation.

**INFORMATION OF INTEREST:** Incorporates swivel connected super ferrite loopstick. Cathode follower output. One pound flywheel. Two position FM (AFC on or off). Sensitivity of 3 uv for 20 DB quieting on FM, 20 uv on AM. Bandwidth 200 KC for 6 DB down on FM. AM sharp 9.5 KC overall on 6 DB down. AM broad 15 KC overall 6 DB down. Meets FCC Radiation Specifications.

**GENERAL INFORMATION:**  
Power Consumption: 65 Watts 110-120 volts A/C 50/60 cycles.  
Dimensions: 13" wide, 4 1/2" high, 11 1/2" deep. Shipping weight 18 lbs.  
Tube Complement: 1-12A7, 1-6X8, 2-6BA6, 1-6AU6, 2-6B10, 1-6X4.

All cantilevered control cabinet models are available in walnut, mahogany, or blonde.



**the Brentwood SR-100**  
Deluxe AM-FM tuner in cantilevered control cabinet .....\$139.95



**the Brentwood SR-100M**  
Deluxe AM-FM tuner with console mounting escutcheon .....\$129.78



**the Claremont SR-200**  
Deluxe control 25 watt amplifier in cantilevered control cabinet .....\$149.95

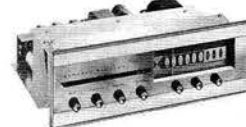

**the Claremont SR-200M**  
Deluxe control 25 watt amplifier with console mounting escutcheon .....\$139.88

**SR-200**  
Here is outstanding achievement in advanced circuit design... pre-amp, completely flexible tone-control, and 25 watt Ultra Linear Amplifier have been combined in one, beautifully-housed unit... audio engineering at its finest with three new FIRSTS\* exclusive only with Sargent-Rayment:

\* **VARIABLE RUMBLE CONTROL** enables you to "pick out" interferences within an extremely narrow range: turntable rumble, A/C hum of either 60 or 120 cycles, or AM-FM program modulation hum are eliminated only within their immediate spectrum without audibly affecting other parts of the programming. This is accomplished through a filter control that varies a 40 DB deep attenuation of a 10 cycle bandwidth throughout the base portion of the audio spectrum (15 to 122 cycles).

\* **VARIABLE SCRATCH FILTER** permits you to eliminate scratch, hiss or whistles of the exact point source of interference without cancelling any more of the frequency range than is necessary to maintain program brilliance. Three variable R-C networks in gang with 14 DB feedback, provide a sharp break low pass filter which attenuates at a rate of 18 DB per octave. Variable from 2400 to 30,000 cycles.

\* **9 POSITION AMPLIFIER CONTROL DIAL** Another SR first functional and beautiful, it does away with the normal visual complexities.

**INFORMATION OF INTEREST:** Bass and treble boost attenuation 15 DB, 40 and 18KC with only 1 DB variation at mid-frequencies. Feedback around every tube. 25 watt output with 1.5% IM and 0.3% harmonic distortion. 6 position equalization. Feedback compensation for both upper and lower frequencies. Phono-AES, LP, FRK, EUR, RIAA, 6th position for tape deck input. The new CRL variable contour (loudness) control.

**GENERAL INFORMATION:**  
Output impedances: 4, 8 and 16 ohms.  
Hum: A/C, tape, tuner inputs -70 DB at 20 watts. Magnetic -60 DB.  
Power Consumption: 100 watts 110-120 volts A/C 50/60 cycles.  
Dimensions: 4 1/2" high, 15" wide, 11 1/2" deep. Shipping weight 27 lbs.  
Tube complement: 2-12AX7, 1-6AN8, 2-EL34(6CA7), 1-6Y3.



thing to help it stand out from the crowd, LC and Will decided to draw upon the company's strength: radio receivers. AM stations predominated in the marketplace, although the Armstrong FM system was coming on strong. Since SR had extensive experience with AM, they decided to produce an AM radio receiver with superior performance to tap into the largest market of the time. The commonly used superheterodyne circuit was felt to be inadequate for top performance, so at the suggestion of one Harry Modine of Brill Electronics (a neighbor of SR), a TRF type receiver utilizing unity-coupled bandpass was designed (SR6AM). To complement the receiver, two integrated amplifiers, the 10 watt model SR10A and 15 watt SR14A/SR15A, were offered, drawing on LC's experience with microphone and jukebox amplification during the Victory Rayment period in the 1930s. These amplifiers featured a separate "Acoustic Balance" control in addition to treble and bass controls, and were of standard design for the period, utilizing either 6V6GT (10 watt) or 6L6GT (15 watt) pairs in push-pull, depending on desired output, along with moderate feedback, oversize Triad transformers, and preamps designed to accept the new low output variable reluctance magnetic pickups. All of these 1948 units were designed to be mounted inside custom cabinets and had exposed chassis, with no cabinetry being available from SR. New marketing efforts were undertaken to line up distributors and representatives who were familiar with the Hi-Fi market, and dealers, particularly on the West Coast, were now introduced to this newcomer to the exciting and rapidly growing field of High Fidelity.

It quickly became apparent to LC and Will that the future was going to be in FM receivers, so a new design was undertaken, and in 1949 the new "EFFEMER" SR6FMR FM tuner, using a circuit licensed from Hazeltine, was introduced. Housed in a rather modernistic cabinet with rounded corners meant to appeal to the "better-half," and covering the entire 88 to 108 MC band (some early radios covered only part of the FM band), it also featured 3 IF stages, separate triode HF oscillator, automatic gain control, automatic frequency control, tuning eye, and switched audio squelch. For those wanting both FM and AM on one chassis, the SR30FAM was introduced, combining features of the new SR FM tuner and the older AM-TRF design, and a lower priced SR29 AM/FM also made its debut. An updated 15 watt amplifier (SR16A) employing two 6SL6GTs, two 6L6Gs, and a 5U4G rectifier was introduced. All Sargent-Rayment products were built to high standards, and this was evidenced by pricing that was at the mid-high end of the range. This would continue through the existence of SR as a reflection of a philosophy from the very beginning that their products would never be "built to a price," to quote a 1949 brochure. The products were well accepted in the areas where they were marketed, and increasing cash flow permitted the new and more innovative designs

which were soon to come.

In 1950, the Rayments became aware that the market demanded an AM/FM tuner with comprehensive pre-amp controls, so they set out to design a product to fulfill this requirement. The resulting SR51 AM/FM tuner turned out to be an important product for SR. Drawing on their vast communications receiver experience, LC and Will departed from orthodoxy and built the best AM tuner of the time: the only AM tuner ever made that was considered to have true High-Fidelity quality equivalent to that of an FM tuner. They used a 2-tube super-low distortion detector design by Selden and Smith that can be found in the Radiotron Designers Handbook (3). To my knowledge, this circuit was never used by any other manufacturer. With IF coils built on an in-house "honeycomb" winding machine that were so superior that McIntosh tried (and failed) to duplicate them, and the new circuit, the result was so good that Consumer Research Bulletin magazine (March 1953) called it "the first satisfactory detector circuit yet observed for high fidelity use in an AM tuner" and an article in Audio Engineering (July 1953), evaluating the then-new SR68 with the same detector, said there had never been "available a radio receiver which provided AM quality which approached FM." High praise indeed! Unfortunately for Sargent-Rayment, AM was dying in the marketplace, and their heroic efforts to make a silk purse out of a sow's ear were not rewarded by an increase in sales figures. To make matters even worse, the first of a series of catastrophes was about to be visited upon Will Rayment.

At the age of only 23, Will was forced by the death of LC to take the reins of total responsibility for the company which bore his name. Involved was design, production, and marketing of all the SR products, a huge burden for a young man, particularly one who had left high school before graduating and never attended college. However, with his vast radio experience and years of work alongside his father, Will was more than up to the task, as the future years would show. Initially the product line was continued unaltered, but Will soon realized that changes would be needed in order to keep up with the demands of a dynamic market. Coincidentally, at that time the US Government awarded SR a contract for a large number of 5 band crystal-controlled radio receivers. This infusion of cash allowed Will to design a new series of Hi-Fi amps and tuners for the 1953-54 season. As the SR51 had been well received, it was left in production, and a newer version SR68 AM/FM (available with the separate SR38 tone control) was unveiled, along with a budget AM tuner SR58. Revised amplifiers included the SR-88 25 watter using 2 6L6G outputs, 5U4G, and Triad transformers, and a new premium Williamson SR98 amplifier with two KT66s and an Acrosound TO-300 Ultralinear output transformer. Early versions of the SR98 had "Ultralinear" stencils, until one day when Will received

a letter from Pennsylvania stating that the use of the word was unauthorized, and to cease and desist lest legal action be taken. Needless to say, the later versions were missing that stencil! There's uncertainty whether Dynaco and Acro products had diverged at that point, but it was probably Herb Keroes who had sent the letter. Keroes was notorious for trying to collect royalties on the Ultralinear circuit, licensing (for a fee) users to put a "K" on any amps with the UL circuit, so it seems likely that he was also responsible.

Overall, the new line was well received and many sales were made at that year's Los Angeles Hi-Fi show. The SR68 received good reviews in the press (Audio, July 1953). There were now 17 reps in the US. The Western reps tended to have other audio lines as well, such as JBL, and were experienced in the business, whereas the Eastern reps were of varying quality. This disparity in sales and distribution between the two coasts was to continue to plague SR over the upcoming years. However, overall sales were on an upward curve, and the balance sheet was in the black. Then the second major setback hit the small and struggling company.

In late 1954, the Sargent Rayment building at 212 9th Street in Oakland was totally destroyed by fire. The records, prototypes and production facilities were a total loss. Even worse, this was at the beginning of the big Christmas selling season, which was responsible for the lion's share of profits for this company and for the industry overall. This situation forced Will Rayment to consider the option of going out of business entirely. At the last minute, however, Will was able to arrange sufficient loans with the bank that enabled new production

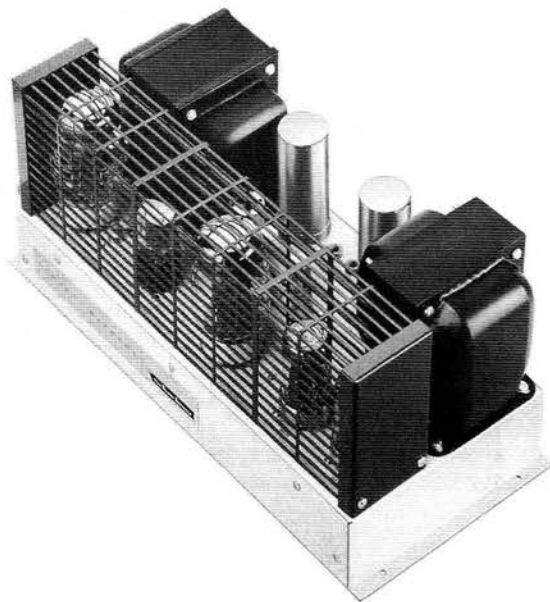

*SR 570 Super-70*

machinery to be installed in an entirely new location at 1401 Middle Harbor Road, still in Oakland. Production was restarted with the help of many loyal employees (who never numbered over 50 over the years) and a new deluxe AM/FM tuner-preamp was introduced, the SR808. Things seemed to be back on track, for the present. Shortly thereafter, however, disaster number three struck.

As things finally seemed to be turning around, Will was suddenly stricken with polio in 1955. Will was responsible for virtually all aspects of running the company besides the actual assembly and testing. However, the employees, faced with the prospect of losing their jobs, were somehow able to keep the ship afloat while Will slowly recovered. He was very fortunate not to have developed permanent paralysis from the disease. It now became apparent that SR would not survive without further capital backing. In view of this stark reality, Will reluctantly began the search for a buyer. A new startup company by the name of Donner Scientific was in need of a production facility to assemble their new electronic instrument line. An agreement was made where Will would sell 100% of the SR stock, but would remain on as President, and continue to manufacture SR Hi-Fi products, and at the same time, assemble the variety of new Donner instruments on the SR production line. Under the 100% buy out agreement, Will was to receive a bonus compensating him based on the SR Hi-Fi profits. New money was to come in in order to promote and expand SR's position in the marketplace.

Will never received any monetary compensation whatsoever. He says today that it was an expensive lesson in business ethics (or lack thereof)! Now desperate to save the company, he was able to arrange to buy back the SR name and machinery, but was immediately forced to find new backing to pay for them. Thus begins another chapter in the Sargent-Rayment saga.

#### 1955-1957 Design Innovation

In late 1955, a group of Silicon Valley investors (they were going strong even then!) were persuaded to lend support to SR based on the excellent product reputation. With the infusion of new funds, Will was able to completely redesign the entire Hi-Fi product line with a daring new approach. Long dissatisfied with the look and function of conventional tuners and amps, Will decided to take a radical step, and hire a professional industrial designer to totally overhaul the SR line. He had met a young designer named Arnold Wolf in one of his periodic visits to a local Hi-Fi dealer. Wolf had experience in industrial design, but was working for the dealer at the time in sales and repairing turntables, not having yet really broken into the business. Will saw a couple of sketches Wolf had on the wall, mentioned his desire to redo the look of his products, and Wolf promptly told him he'd come up with some ideas on paper. A few weeks later, Will got his first look and was

# SR-5100

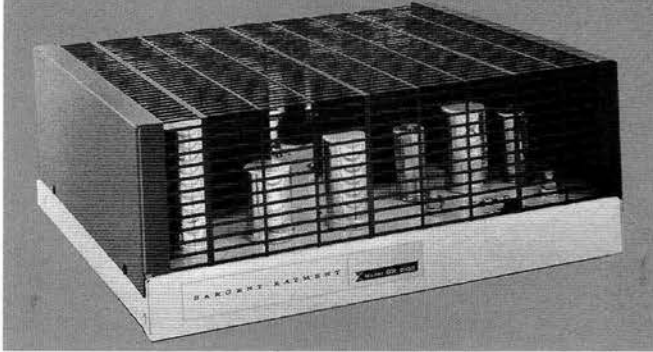

bowled over by what Wolf had created: here was a totally new and ergonomic concept for high fidelity products! Cantilevered front panels were used in order to facilitate manipulation of the numerous knobs and controls without bending over or holding the wrist at an awkward angle, and luxurious wood cabinets in three finishes were added. This gave the new amps and tuners a handsome and unique appearance. They were attractive as free standing units, obviating the need to place them in expensive floor cabinets. This new look had the additional benefit of immediately setting them apart from any other product. Will believed that Wolf's redesign was a major advancement and it formed the basis for the entirely new 1956 line of "Cantilever Control" Sargent-Rayment products. The technical side was not ignored either, as an all new amplifier with variable rumble and scratch filters (Claremont SR100) and a new tuner (Brentwood SR200) were introduced in the innovative packaging, along with the Maywood SR300 combination of basic amp and preamp/tuner. The Maywood amp section was available as either a 20 watt 2x6L6GC/5U4G ultralinear design with potted Chicago Standard output transformer and power transformer by Kapitol Magnetic of Chicago, or as a 70 watt 2xKT88/GZ-34 version with modified Mullard circuit and both transformers by Kapitol. The 100 amp had a new variable scratch filter that was claimed to be the most effective ever developed, with 18 db per octave attenuation vs the typical 6 db. It looked like a banner year with extremely forward looking and attractive designs. Unfortunately for SR, the new line was accorded a collective yawn by the buying public, and sales plummeted, a major disappointment after the extensive (and expensive) re-design. Puzzled by this development, Will finally determined that the reason for this was rather simple: the sloping front panel made it impossible to mount in a cabinet, especially one with doors. The "spouse factor" had not been accounted for or accommodated! Thus for 1957 a retro-fit kit with flat panels was rushed into production, and sales picked up

# SR-8000

Deluxe STEREO AM-FM TUNER and PROFESSIONAL CONTROL CENTER



somewhat. This setback had no effect on Arnold Wolf's career, however, as he had met the President of JBL through Will, and eventually became responsible for the look and design of all JBL products, including the Paragon speaker and the famous JBL exclamation point logo. To cap it off, in 1969, he became President of JBL, staying well into the 1980s. He also continued to design all SR products, brochures, and Hi-Fi show displays until the end in 1961. The disappointing sales of the new 1956/7 line meant dwindling resources once again, and the search for new funding led to the most bizarre chapter in the long history of Sargent Rayment. This was the GARD episode.

## Sargent Rayment 1958-1961: Brave New World

Back at square one once again, Will was forced to consider yet another financial rescue plan. An investor group representing several top nuclear scientists had been searching for a location to produce a strange new gizmo that had been developed at the Lawrence Livermore Laboratories. It was the height of the Cold War, people were building bomb shelters in their back yards, and grade schoolers were practicing air-raid drills by diving under their school desks (something I remember all too vividly!) Livermore Labs had devised an inexpensive and reliable go/no-go radioactivity detector which could be made in quantities and sold to the public in order to provide a cheap and simple way of knowing when or if it was safe (!) to come out after a Soviet nuclear attack. What was needed was a place with electronics experience and production machinery to make it. It was decided that that place was Sargent-Rayment. The backers included the world famous Luis Alvarez of Livermore Labs, known also as one of the fathers of the H-bomb. With this kind of prestigious pedigree, Will decided to go along, with the proviso that the Hi-Fi line be allowed continue to exist alongside the new contraption, which was known as GARD. This stood for "Gamma Atomic Radiation Detector," and the SR logo had a small addition made to it: underneath the company name, it now said "Nuclear and Electronic Devices."

SR had entered a Brave New World! The new detector had been proved in Nevada during early nuclear tests, and Will has, to this day, letters from the Army observers who testified to its effectiveness. One has to wonder how many years they survived after that exposure to radiation! Dr. Alvarez also provided Will with a document with his personal testimonial to the new device's success.

It was a new world for Will, but again new backing gave him the means to develop new and improved electronics for 1958. Stereophonic sound was now on the scene, and SR had to meet the challenge of quickly coming up with a completely revamped product line. Once again, Will was up to the task: the new "Stereo Reproducer" lineup of products was the result. The 70 watt KT88 amp version from the SR300 combo was sold individually as the SR570 "Super Seventy." A new SR 517 EL-84/GZ-34 amp was sold as a smaller mono alternative, and the stereo version SR534 amp was essentially two 517s on one chassis. An SR380 AM/FM with Stereo Preamp (and provision for MPX out) was introduced as well.

All of the amplifiers had oversize power transformers so that the tuner/preamps could be externally powered, allowing for cooler operation and additional quietness in the sensitive preamp circuits resulting from the removal of the power supply from the tuner/preamp chassis. SR would continue with this feature through 1961. A separate SR900 power supply was available for those wishing to use non-SR amps. The big news for 1958 was the first SR stereo integrated amp, the SR17-17, with 2 EL-84s per side. Rectification was by GZ34/5AR4 which was universal on all SR amps from 1957 through 1961, the larger amps using 2. Typically 6AN8s or 7199s were utilized. For the new Stereo line, after extensive testing, SR switched exclusively to Kapitool Magnetic, makers of the excellent Heath outputs, as transformer supplier. Testing verified that quality was excellent and SR would continue to use them from 1958 through 1961. Sales improved markedly in response to the new stereo designs, but the bad news was that the GARD venture was rapidly going down the drain. The government had decided to award the actual production contract for Civil Defense to Bendix for political reasons, and the Livermore investors decided to bail out in 1959 as a result. However, improved sales of the excellent new stereo line for 1958 allowed SR to operate at a profit.

1959 brought an expansion of the Stereo Reproducer line of 1958. An all new SR7000 AM/FM preamp with a black panel look joined the fray, and best of all, a premium new line of high end separates joined the "Super 70" monoblocks. These now rare units were the SR1000 AM/FM Stereo Tuner, still using the advanced 2 tube SR AM detector, an all new Stereo EL-34 SR5100 (50+50 watt) basic stereo amp, and the first (and only) SR Stereo Preamplifier, the SR2000, which, as was typi-

cal for SR, drew power from the amp, and had a unique lighted rotary master function knob in the center of the faceplate. These were top of the line units, and were of typical SR quality, with all point to point wiring, the wiring being bundled and harnessed, an 8 hour burn-in before alignment and biasing, high grade components, and a 15 month warranty in a time when 90 days was very common in the industry. Six FM stations in California alone used SR equipment for signal monitoring, a testimony to their favorable reputation.

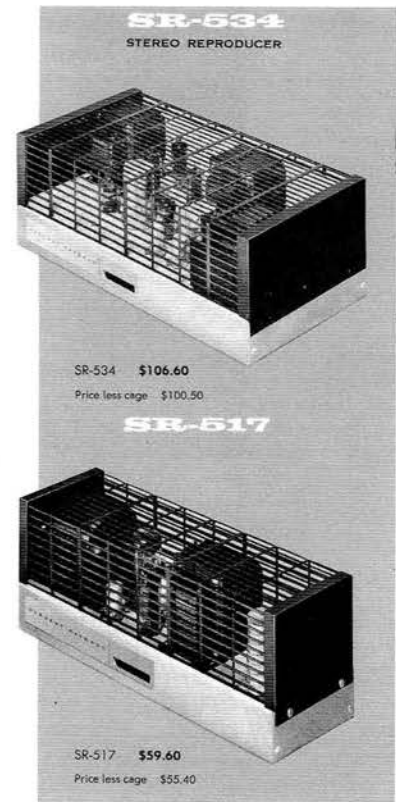

One hallmark of SR amp design was reduction of heat. Amplifier chassis were made large with spread out components for extra long life. (Will Rayment has now been using his SR5100 in conjunction with an SR8000 tuner for 43 years with no problems except tired tubes!) The SR5100 EL-34 amp chassis is almost twice the size of the Fisher SA-300 for example. The hottest resistors were mounted on top of the chassis deck for cooling, instead of underneath, and the power transformer was quite large for an EL-34 amp. All of this attention to detail paid off in spades with excellent reviews in Radio & TV News and Audio, and further improvement in the sales figures.

1960 saw the new deluxe SR8000 AM/FM stereo pre-amp/tuner and a new economy SR1020 FM only stereo tuner. Also a first was SRs new stereo FM receiver, the SR1040 (4-6BM8 outputs) and SR1030 mono FM receiver (2-6BM8s). Rounding out the 1960 line, the re-arranged-layout SR534 was now called SR540 and using 7189s for 20 watts/ch, and the mono version was the SR520. The SR380 tuner/preamp was discontinued in favor of the new SR8000.

The Hi-Fi line of "Stereo Reproducers" was gaining momentum, but with the Civil Defense group in Battle Creek, Michigan unwilling to recognize GARD, the Physicist group wanted out of SR. Will had to give up stock control when the new group joined SR, so was not even considered when they, as a block, voted to sell

their stock to Sky Data, a subsidiary of Atlas Corporation, New York. It wasn't long before the bean counters from the East arrived. They were sent out to oversee the SR operation, though none had any experience in the electronic field. One of them even boasted that in the previous year, he had lost \$250,000 on an airport project in New Jersey. Will was allowed to remain as President, but immediately became leery when his newly appointed general manager announced that SR would quadruple its sales in the following year. Will asked how this could happen, finding that it would take a large infusion of money to promote such an increase in net sales. He insisted on a cash flow sheet to assure this gigantic undertaking would be properly financed. The general manager told Will, to his face, "he was a naive and inexperienced business man to think that bills had to be paid to suppliers, advertisers and reps in less than three months" (normal terms are 30 days net.) At that point, Will made the gut-wrenching decision to leave the company he, his father, and Ed Sargent had founded. So as to not endanger his own good reputation with suppliers, he resigned in December 1960. Though SR was making a profit upon Will's departure, in less than a year, SR declared bankruptcy, never to re-emerge. Sargent Rayment Company, one of the oldest of Hi-Fi manufacturers, was gone.

**Postscript:**

Will had some amusing anecdotes to relate, having met most of the early Hi-Fi pioneers at numerous trade shows over his many years in the business. There was the time Avery Fisher stopped by the SR booth and remarked that the product was "excellent and it would give me some worry if more attention were paid to the details!" Will wasn't quite sure how to take that left-handed compliment, but was flattered nonetheless. It's true that SR didn't have the polished look of the Fishers! Avery had been a book designer before he got into Hi-Fi, after all...Another time at an early Hi-Fi show when credit cards were something of a curiosity, a group of fellow manufacturers went out for dinner, and having finished, the always unpredictable Paul Klipsch whipped out his wallet, held his arm way over his head and let fly an accordion of at least 20 credit cards and quipped... "Gee, I wonder which one I should use!" Always the showman! Will said Klipsch was pretty hard of hearing too...a very interesting quality for someone who made speakers! According to Will, he claimed he could "feel the sound

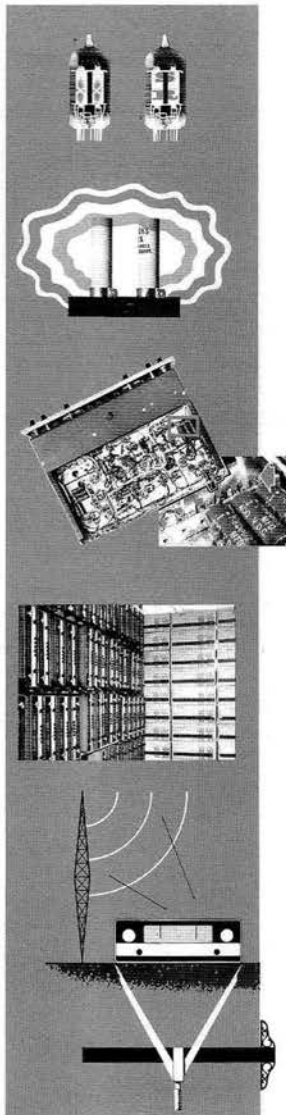

**3 Long-Life Design**

Of all the precautions taken to insure maximum performance from your circuits, conservative tube operation is possibly the most important. Years of experience have taught SR that tube voltages should never exceed the tube manufacturers' recommendations. Many designers

ignore this rule in an effort to squeeze higher wattage from their circuits. In these cases "cherry spots" will appear, significantly shortening the life of the tube. But...you will never find a "cherry spot" in an SR product!

**4 Maximum Stability**

No design—however advanced—can operate reliably year in and year out unless its components are completely stable. This is why SR takes extreme care to keep heat dissipation within the chassis to a minimum. For example, all heat-producing resistors are mounted on top of the

chassis rather than inside, which effectively prevents the internal ambient temperature from rising and damaging sensitive components. Try the hand heat test on other products. You'll find SR cooler by far.

**5 Superior Construction**

Precision construction is essential if the full advantages of advanced design are to be realized. This is the reason SR uses the military style "harnessed cable" wiring technique. Although much more expensive to produce, harnessing is still the best way to maintain perfect alignment in a tuner despite the shock and vibration encountered in shipping. Note, too, that hand wiring, often with "ladder" type terminal board

construction, is employed throughout the line. No hard-to-repair printed circuits are found in SR equipment.

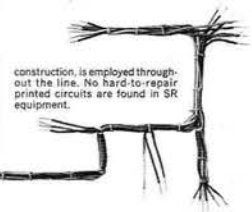

**6 Inspection**

Until the day of complete automation, the human element of error will be a strong determining factor in the quality of any device. Therefore, the SR company has again adopted a technique used by the military in order to eliminate faulty workmanship. Pictured here is the underside of a typical SR unit with its hundreds of soldered connections. The enlarged section shows how SR inspectors

mark every joint with red, thus assuring themselves and the consumer that every connection has been thoroughly inspected. Also note that each wire has been securely wrapped around its terminal lug before soldering to provide a mechanical as well as an electrical bond. This procedure assures years of trouble-free, noiseless performance.

**7 Pre-alignment Burn-in**

Today's components, such as condensers, resistors, inductances, tubes, etc., are superior to those used in earlier high-fidelity units. But despite this improved performance, there is still some "seating" and "drifting", which occurs whenever these elements are first subjected to actual operating conditions. Because of this, SR

has established a policy of "pre-final alignment burn-in." Each SR tuner is allowed to run at full voltage for a period of at least eight hours before final precision alignment is done. Consequently, SR can offer its unique guarantee of lasting alignment and peak performance.

**8 15 Month Guarantee**

Only by means of the above "seven steps to better performance" could a manufacturer be so assured of his products' enduring superiority as to give a 15 month guarantee. This is precisely why SR is the only component manufacturer in the high-fidelity industry giving this extended warranty.



**9 Used Professionally**

All the evidence we have presented can be confirmed on the test bench—which is where the professionals do their judging. And many of these experts—especially those whose business is the reproduction of quality music—prefer SR tuners and amplifiers. For example, in San Francisco alone, the fol-

lowing FM stations (representing more than half of the total) use standard SR equipment for monitoring: KHP, KBAY, KJAZ, KSFR, KAFB, KQBY, KBOD. It is very possible that your good music station uses SR too.

**10 Outstanding Appearance**

The bonus quality that comes with better-performing SR equipment is its striking appearance. Styled by Arnold Wolf Associates, noted industrial designers, SR components reflect the best elements of contemporary design thinking and human engineering. Architects and interior designers characteristically specify SR for

custom installations because they recognize its beauty and unique ability to harmonize with either modern or traditional decor. The Albright Art Gallery recently selected SR for inclusion in its distinguished "20th Century Design" exhibition. Esthetically or functionally, Sargent-Rayment is the choice of professionals.

**1960 Sargent Rayment Features**

in the seat of his pants!" Will related that H.H. Scott was known by all as Herman "Hormone" Scott, presumably due to his aggressive pursuit of company market share! Will mentioned to Scott once at a show that his oil ship during the War had had an H.H. Scott entertainment receiver for the crew's listening pleasure, and H.H. seemed quite pleased. Just a few of Will's memories from the early days of Hi-Fi...

Upon departing SR, Will joined Fisher Berkeley Corp, as Executive VP. They were a manufacturer of industrial intercoms and audio visual nurses-call equipment. Three years later, will obtained controlling interest in Logan Sales Company (electronic equipment reps.) At age 57, Will sold Logan Sales to his employees and retired to the good life with his wife Marilyn. He still listens to background music from his SR8000/SR5100 combo, but when he is up in the barn, he enjoys his SR707 (1954) /SR14A (1950) combo.

# Dumpster Tubes: Compactrons

by John Atwood ©2003 All Rights Reserved

The last gasp of the consumer tube industry or a logical evolution of tube design that got killed by transistors? Compactrons could be considered both. In the late 1950s cheap transistors seemed a long way off, but competitive price pressures in the American consumer electronic industry were strong. Automated parts loading of PC boards was becoming widespread. Each of the major tube manufacturers had a scheme to reduce costs: Sylvania came out with "T-9 novals" (such as the 6JM8 and 6GM5) to allow the use of cheap 9-pin sockets for moderate power tubes, RCA came out with the Novar base, to eliminate the slight extra cost of octal bases for power tubes, and GE came out with Compactrons.

Introduced by General Electric in June, 1960, Compactrons were promoted to engineers as a way to both eliminate the octal bases in power tubes and to consolidate low power functions into fewer tube envelopes. The 12-pin base allowed up to three triodes or two pentodes, and the T-9 (1 1/8" diameter) and larger envelopes handled power well. The tube count in a TV set could be reduced by 30% or more, with the resulting lower assembly cost and better reliability. GE was the inventor and main marketer of compactrons, but Tung-Sol and later Sylvania originated some designs. RCA shunned the low-power multi-function types, but made some power types. The main Japanese electronics companies made Compactrons, both for the American replacement market and for some of their own TV sets. No Compactrons were made by the Western European or communist-bloc countries.

Compactrons were designed for the consumer electronics market, and most went into both black & white and color TVs. A few found their way into Hi-Fi

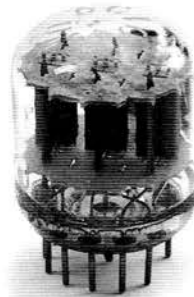

GE 6C10



Philips (USA) 6AC10

equipment (the Scott 370 tuner and Macintosh MX-110 pre-amp/tuner), test equipment (Heath and Knight oscilloscopes), and ham radio equipment (the Heathkit SB-100 series). GE made a few special UHF power types for 2-way mobile radios (i.e. 7984, 8156). Compactrons arrived too late to go through the

Type	Triode #1			Triode #2			Triode #3		
	Mu	gm	like	Mu	gm	like	Mu	gm	like
6AC10	62	5800	½ 12AT7	62	5800	½ 12AT7	62	5800	½ 12AT7
6AK10	53	7000		53	7000		53	7000	
6AV11	17	2200	½ 12AU7	17	2200	½ 12AU7	17	2200	½ 12AU7
6BK11	70	1550	½ 5751	100	1600	½ 12AX7	100	1600	½ 12AX7
6C10	100	1600	½ 12AX7	100	1600	½ 12AX7	100	1600	½ 12AX7
6D10	57	4200	½ 12AT7	57	4200	½ 12AT7	57	4200	½ 12AT7
6K11	17	2200	½ 12AU7	100	1600	½ 12AX7	100	1600	½ 12AX7
6MJ8 *	17	3000	½ 12BH7	17	3000	½ 12BH7	17	3000	½ 12BH7
6MN8 *	50	9000		50	9000		50	9000	
6Q11	18	2500	½ 12AU7	100	1600	½ 12AX7	100	1600	½ 12AX7
6U10	17.5	2300	½ 12AU7	98	1600	½ 12AX7	17.5	2300	½ 12AU7
7688	17	2200	½ 12AU7	17	2200	½ 12AU7	17	2200	½ 12AU7
7689	100	1600	½ 12AX7	100	1600	½ 12AX7	100	1600	½ 12AX7
7690	60	5500	½ 12AT7	60	5500	½ 12AT7	60	5500	½ 12AT7

\* = common cathode

Table 1: Triple Triodes

ruggedization and qualification processes needed for avionics and military use; transistors were already replacing tubes. Hence, they were essentially a consumer electronics product. Interestingly, GE had plans for a two-tube Compactron set to replace the "All-American Five" table radio tubes as well as a two-tube 12 volt hybrid car radio set, but these types never went into production, due to transistor competition.

The damper diode and dissimilar dual triode Compactrons have been covered in previous VTVs (issues #12 and #17). This article will cover only the myriad of low-power multi-function types. Fortunately, most of these Compactrons were combinations of previously-released types, allowing engineers to "Compactronize" existing designs. Tables 1, 2, and 3 show the important characteristics of these multi-section types, as well as earlier equivalents, if applicable. Most of the types listed have

Type	Pentode #1				Pentode #2			
	gm	Plate	type	like	gm	Plate	type	like
6AD10	6500	12	AF output	6DT5	2500	1.7	dual-control/FM det.	6GX6
6AF10	10000	3	IF amp.		23000	5	sharp cutoff/video amp	½ 6KV8
6AL11	6500	10	AF output	6DT5	1000	1.7	dual-control/FM det.	6DT6
6AR11	10500	3.1	rem.cutoff IF amp.		10500	3.1	rem.cutoff IF amp.	
6BF11	8600	6.5	AF output		1000	1.7	dual-control/FM det.	6DT6
6BN11	13000	3.1	sharp cutoff IF amp	6EW6	13000	3.1	sharp cutoff IF amp	6EW6
6BV11	3700	1.7	dual-control/color demod.	6HZ6	3700	1.7	dual-control/color demod.	6HZ6
6BW11	8500	4	sharp cutoff/video amp	6AU8	13000	3.1	sharp cutoff	6EW6
6BY11	4900	10	AF output	6EZ5	2500	1.7	dual-control/FM det.	6GX6
6J11	13000	3.1	sharp cutoff IF amp	6EW6	13000	3.1	sharp cutoff IF amp	6EW6
6T10	6500	10	AF output	6DT5	1000	1.7	dual-control/FM det.	6DT6
6Y10	8400	4.8	AF output		3700	1.7	dual-control/FM det.	6HZ6

Table 2: Dual Pentodes



*Sylvania 6AV11*

0.3A, 0.45A, and 0.6A series-string equivalents. To save space, these equivalents are not listed, but will be recognizable by their different first digits in the type number. For triodes, the amplification factor (mu) and the transconductance (gm) in micro-mhos are given. For pentodes, the transconductance and maximum plate dissipation rating in watts (listed under "Plate") are given, as well as the original intended usage. For more detailed information, refer to tube databooks or on-line datasheets such as at [www.tubedata.org](http://www.tubedata.org).

Most of the Compactrons are built with conventional triode or pentode assemblies on a pair of common horizontal mica spacers. A few, such as the 6BH11, have

Type	Pentode				Triode #1			Triode #2		
	gm	Plate	type	like	Mu	gm	like	Mu	gm	like
6AF11	11000	5	sharp cutoff/video amp	½ 6GN8	68	5500		41	4400	
6AG9	30000	10	sharp cutoff/video amp	12HG7	39	4600	½ 6AU8			
6AH9	21000	10	sharp cutoff/video amp	½ 6JT8	20	2750	½ 12AU7			
6AK9 *	6200	10	Vertical output		43	3900	½ 6AU8	20	2350	½ 12AU7
6AL9	30000	10	sharp cutoff/video amp	12HG7	59	6300				
6AS11	10500	5	sharp cutoff/video amp	½ 6GN8	68	5500		41	4400	½ 6AU8
6BD11	10400	4	sharp cutoff/video amp	½ 6GN8	68	5500		41	4400	½ 6AU8
6BH11	7500	2.5	sharp cutoff		46	8500	½ 6GH8	46	8500	½ 6GH8
6CA11	21200	5	sharp cutoff/video amp		63	6300		69	5500	
6JZ8	7100	7	Vertical output		20	2350	½ 12AU7			
6LU8	9300	14	Vertical output		58	3600	½ 12AT7			
6M11	13000	3.1	sharp cutoff IF amp	6EW6	58	8000		58	8000	
6MF8	4100	12	Vertical output	6EZ5	58	4100	½ 12AT7			
6MY8	9300	16	Vertical output		58	3600	½ 12AT7			
6T9	6500	12	AF output	6DT5	95	2100	½ 12AX7			

\* = common cathode

**Table 3: Pentode + Triode(s)**

their sections mounted "sideways," though. They also varied in height from the short, squat 6C10 to the tall 6MJ8.

Figures on the bottom right show an interesting collection of 6JZ8 types. From left to right are: a Raytheon-branded Japanese 6JZ8A most likely made by Toshiba, a Zenith-branded Sylvania 6JZ8, and a Raytheon-branded 6JZ8A made in Taiwan, most likely made at Westinghouse's plant there. The Taiwan tube is unique in having a top seal tip.

The tube sections in Compactrons are typical of the American TV-type tubes: high transconductance types, reliable, decently made, but not to premium Western-European or Mil-Spec standards. For current new designs, the triple triode types are handy in general audio circuits. The power-pentode/triode types or dissimilar dual triode types are handy in series voltage regulator circuits. The high-transconductance video pentode/triode types work well in shunt regulator circuits. The dual-control pentode or 6BN6-type sections are not very useful for audio, but have radio applications as mixers, product detectors, and limiters. Compactrons have held a special interest for hams in home-brewing minimum tube-count radios.

Disdained by tube connoisseurs as junk tubes for cheap TV sets, Compactrons are actually well-designed tubes, made mostly by GE or Sylvania to good production standards. Although they haven't been manufactured for over 20 years, there are many thousands of them clogging up old tube caddies. For a compact one-off project, they are cheap, available and interesting.

**References:**

1. General Electric, **Essential Characteristics**, 1974
2. Sibley, Ludwell, "The Long-Ignored Compactron", **Tube Collector**, Vol. 4 No. 6, Dec. 2002, pp. 16-19.



*Sylvania 6AG9*



*Sylvania 6MJ8*



*GE 6BN11*

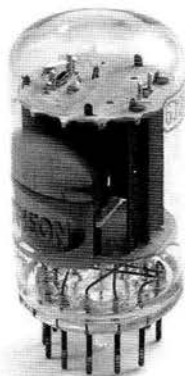

*Raytheon (Japan) 6JZ8*

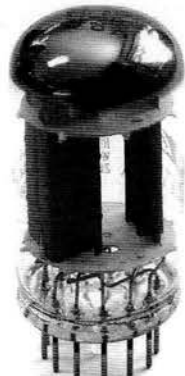

*Sylvania 6JZ8*



*Tipped 6JZ8*

# Reactance Reaction: The Welborne DRD 2A3 Amplifier

A review by David Bardes ©2003 All Rights Reserved

If you have been reading VTV for a while, you are familiar with Jack Elliano. He is our cartoonist, as well as a designer and manufacturer of audio transformers. He presented a couple of amp projects in VTV featuring his direct reactance drive circuit (See issues #10 and #14). If you have had any interest at all in tube amp kits, you are also familiar with Ron Welborne of Welborne Labs. Ron has been offering quality amp kits and mods for many years now.

Ron has replaced his bread and butter amplifiers, the Laurel 300B amps and the 2A3 Moon Dog amps, with a new series of SET amps, the DRD amps. The DRD amps incorporate this same direct reactance circuit. The convergence of Jack's circuit with Ron's amp building prowess has resulted in a very, very musical line of amps.

The direct reactance circuit provides musical gains by removing the adverse sound of the power supply caps from the signal path. This is done by diverting the return path from the output transformer to the cathode of the output tube via a single high quality capacitor, instead of going directly to ground and the power sup-



*Your bias is too high, plate current too low, and you are operating nonlinear with resulting high second. Also complications from a mismatch. If your output is parafeed, you could pop a cap!*

ply caps, as is usually the case. A choke loaded driver stage provides ample voltage swing and is the other unique feature of this circuit.

Welborne Labs offers these mono block amps specifically tuned and optimized for your favorite output tube - as long as you like 45's, 2A3's or 300B's. Our review sample employed 2A3's. Available as kits or completed amps, the DRD amps have many options, including some premium part upgrades and your choice of tube or fast recovery diode (HexFred) rectification. Ron's description of the amps, on his Web page, states that the solid state rectification works a little better. I believe Ron thought we might accuse him of being a Solid State lover if he sent us anything but the tube rectified version, and so that is what we received. In the end, it probably makes little difference. This is a nice sounding amp!

While I didn't build this amp, I could have. The instructions were complete and included several color illustrations which showed how the amp was to look during the assembly process. Like the Moon Dog amps, the DRD amps are mono block Bud Boxes with nice Alderwood bases. A black anodized plate supports the tubes and transformers and all the connections and the power switch reside in the back. The layout is set as a mirror image and the amps look smart placed side by side.

The review amps were provided with TJ mesh plate 2A3's. In my system these sounded thin and remote and so I changed them out for some JJ 2A3's. This brought the music back into my living room and the JJ's stayed in place for the duration of the review.

Compared to my very good 300B amp, the DRD possessed a larger soundstage, more detail and fullness, better bass clarity and extension and, best of all, better pacing. The DRD amp was quieter and so I could hear further into the music.

On "I Got It Goin On" by US3 (*Hands on the Torch*), the bass was really extended and clean, even at loud volume levels. No, it didn't have the clout that a good push-pull amp would have delivered, but there is no need to apologize for soft, mushy or bloated "single-ended bass" with this amp either. Through my Khorns, the bass was deep and tight.

I turned up the volume for the Talking Heads, "Girlfriend is Better" (*Stop Making Sense*, Sire Records) and the DRD amp maintained its composure while delivering loud, tuneful music with a great timing and without strain.



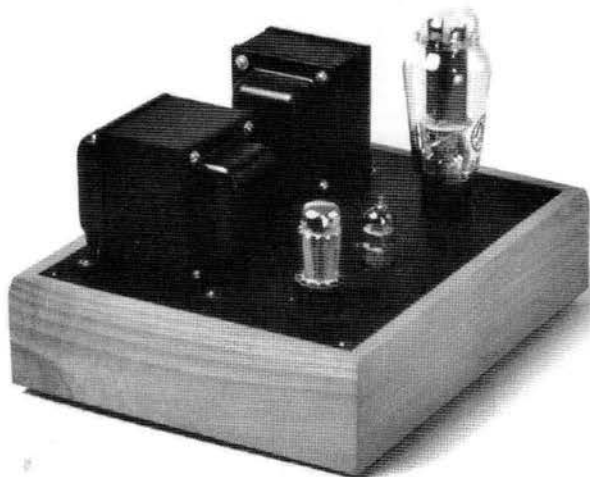

No wheezing or musical constipation was observed. I rarely listen to this CD because through my rig, it sounds gritty as many mid 80's recordings do. But because the presentation through the DRD amp provided such a good pace, I found myself enjoying the music and not reaching for the remote. I wasn't aware that my present amp was a little slow, but with the DRD amp to compare it to there is definitely room for improvement.

Playing Paul Simon's "Can't Run But" (*The Rhythm of the Saints*, Warner Brothers), the DRD amp showed off its ability to reveal inner detail and keep dense musical passages distinct and clean. The three marimbas and multiple percussion instruments all were nicely placed in a large and deep soundstage. On Ronnie Earls "Ice Cream Man," (*Grateful Heart Blues and Ballads*, Bullseye Blues) the reverb on Ronnie's guitar was crystal clear and silky smooth and yummy!

If I were to be picky and look for something to complain about, I would have to say that the DRD amp is just a little laid back and a wee bit distant. The soundstage is set back a few paces from the speakers and the music isn't as visceral compared to other 2A3 amps I've heard. But believe me, I am not complaining because this amp has some personality and errs on the side of grace! I could and did listen to this amp for long periods of time without any fatigue. A more aggressive amp might not be that listenable in the long run.

The Welborne DRD 2A3 amp possesses all the charm that a good 2A3 amp should have. It has great pacing, a big beautiful soundstage and lots of clarity and transparency. It also is free of warts like mushy bass or limited high frequency response. As a kit, it is easy to build with the comprehensive instructions and small parts count. I don't see how you can lose!

<b>Dynamic Range</b>	<b>Transparency</b>	<b>Frequency Extension</b>
4.5	4.75	4.5

<b>Dimensionality</b>	<b>Pace &amp; Rhythm</b>	<b>Musical Involvement</b>
5	5	4.75

**Overall Score: 4.75**

**Test System Components:**

Jolida JD 603 CD player with Mullard CV4004 tubes in the analog output section

Assemblage SET 300 amp with JJ 300B tubes

Klipschorn loudspeakers

Omega Super 8 loudspeakers with Skylan speaker stands

Homebrew fine wire speaker cables

TEK LINE PC -12 Signature power cords for both the amp and CD player

Nordost Blue Heaven and VSE Super Clear interconnects

**Welborne Labs**

9475 S. University Blvd. #411

Highlands Ranch, CO 80126

303-470-6585

**Some things should never sag.**

**And some things should.**

**Maven Peal® Zeeta**

.5/15, .5/30 & .5/50

Unprecedented response to your touch...

1270 Peck Hill Road • Plainfield, VT 05667  
802.456.1607 • www.mavenpeal.com

# Designer Profile; Steve Carr of Carr Amplification

By Charlie Kittleson ©2003 All Rights Reserved

Steve Carr of Carr Amplification has a very popular line of guitar amps used by artists and studio musicians around the world. We recently interviewed and profiled Steve and talked about his background, amps and design philosophy.

*VTV: When did you first get interested in guitars and amps? Did you play in bands? Tell us about them.*

SC: As long as I can remember I have had a curiosity about how things work, especially machines. I joined my first band the summer before my freshman year in high school. We weren't very good but once you start - you can't stop.

Guitar gear and most especially tube amplifiers fascinated me. I did not start working on them till I was in my late 20s after I befriended the best amp tech in Chapel Hill NC. Things proceeded fairly quickly from there due to an insatiable yearning to understand and build my own amplifiers. I have been in around 15 bands over the years - nearly all of them original music with a few national CD releases (The Emperors of Ice Cream 1992 and Stratocruiser 2000). Currently I am in two groups: The Breaks and The X-Rayons. I play mostly rock though I have been in a few jazz groups.

*VTV: What is your education and work experience in electronics?*

SC: I went to Purdue University for Aerospace Engineering after high school and much later I returned to school at the age of 30 for Physics (University of North Carolina) after a 10-year effort to succeed as a recording artist. My main source of money was waiting tables at fine restaurants - the electronics I learned mostly on my own - reading old texts from the 30s, 40s, and 50s plus a lot of trial and error. I ran a small side business repairing and modifying guitar amps for a

number of years before I started Carr Amplifiers in the fall of 1998.

*VTV: When and where did you start Carr Amplifiers? What was your first amp design?*

SC: The business grew out of my home repair and mod shop in Chapel Hill NC. I think of the company starting with the first amp sale, which was in December of 1998 to Indoor Storm in Raleigh NC. They took a risk and bought the first two Slant 6V amplifiers (my first model). In January Eddie Berman, head salesman at Indoor Storm, sold one of them and in a lot of ways I could not believe it - It was a dream coming true and I have felt that same way with every subsequent sale. We have shipped just over 1000 amplifiers as of this month. I feel very fortunate.

*VTV: What is your basic design philosophy? Are your circuits unique in any way?*

SC: I believe in simplicity, real world features, rugged 40s era hand wiring, and a mix of classic 50s and bleeding edge modern aerospace components. We make 5 models and each has certain classic guitar amp inspirations.

That said, we do not make clones of older designs. I try to identify elements I like in the great amps of the past, then take a step forward. The most unique aspects of our designs have to do with the ways these different classic circuit ideas are combined and in some ways my interpretation of what those circuits imply. The way the amps make music and the interactive feel they have

with the player are the final judges for each design effort.

*VTV: How do you determine which transformers to use? Are they proprietary designs?*

SC: I usually have primary impedance in mind as I start prototyping a new amp based on output tube type and voltages. Then I discuss it with our transformer manufacturer's head designer, Bill Manousos at TMI in Chicago, and get a few different prototype transformers. Each is wired into the circuit and evaluated for tone and feel. After I determine the best transformer, we have them produced. Each of the 5 models uses proprietary



Steve Carr  
Holding a Mercury  
Amp

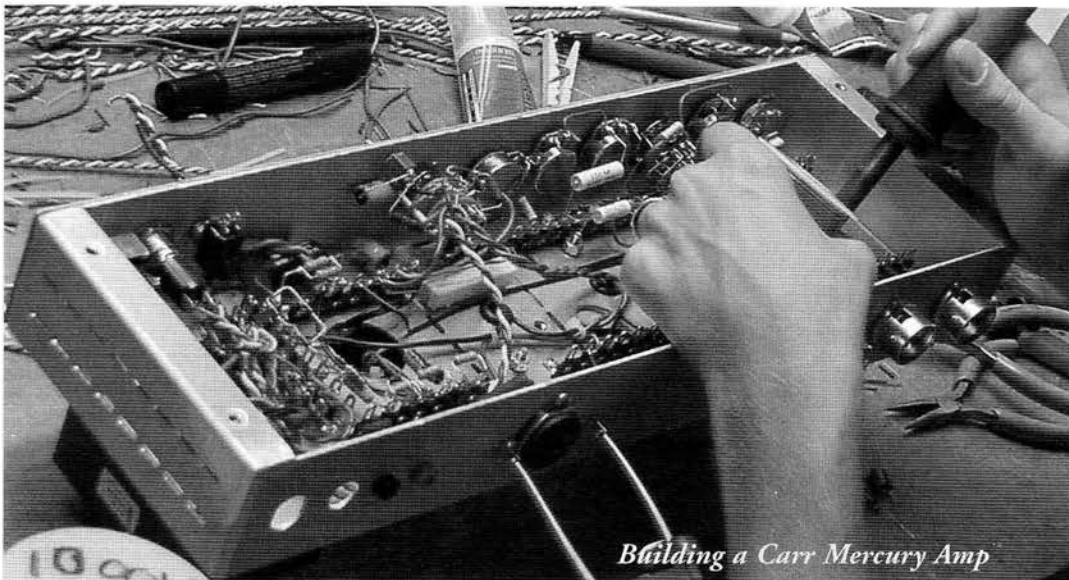

*Building a Carr Mercury Amp*

SC: This is a great question. Ultimately I am driven by my own personal musical taste. I do think about customer comments and what I believe people want but the final decision is guided by the music I have enjoyed throughout my life.

A very large record collection and long experience with fine guitar amps grounds me in classic guitar tones! When it sounds right - you know.

power, output, and choke designs.

VTV: *Why are you using aluminum chassis in your amps?*

SC: Three reasons: electrical conductivity, it's a non-magnetic material, and weight savings (I don't have roadies!)

VTV: *What is the advantage of using Solen Poly caps in the power supply? What about HEXFREDS, are they really better than tube rectification?*

SC: It is interesting to remember that after the first gain stage the actual signal from the guitar ends and copies of it are made with increased voltage as you go from stage to stage in the amp. After that first stage you are essentially listening to the amps power supply which is the medium the copies are made of. Once you understand that, the importance of the power supply becomes clear. I have found the Solen Poly caps yield much faster transients, more open sound, and a warmer overall vibe with better feel than the typical electrolytic cap. They are more expensive and larger, but the sonic rewards are very worth it. Also they will not need to be replaced like electrolytic caps, whose lifespan can be as short as 10 years, depending on brand.

Also, we are using new technology Ultra Fast Recovery rectifiers on all the models except the Slant 6V (which uses a 5AR4 tube rectifier in tribute to the Blackface Deluxe). These rectifiers sound great and are without the grain and haze people have come to associate with run of the mill silicon rectifiers. I don't think of them as better than tube rectifiers but as sonic equals with greater speed and current capacity. There are other circuit elements in our amplifiers that partially mimic tube rectifier sag to add the nice bounce you get with tubes but without reliability liability.

VTV: *How do you determine what good tone is?*

VTV: *Besides the Rambler amp, what are some of your other amplifier models and what applications would you recommend them for?*

SC: We currently make 5 amp models ranging from 8 to 80 watt output. The Mercury Compact 1-12 combo with an 8 watt single ended fixed bias Class A KT-66 power tube. The Mercury has a lush reverb and a 3 position Boost yielding tones from classic 60's American to British rock. A 4 position built in attenuator lets you choose from 8, 2, 1/2, or 1/10th watt output to the speaker. The Mercury is great for late night home playing, all studio work, and moderate volume live shows. I use mine in a 5-piece band on the 2 watt setting at practice and then I give 'em the full 8 when we play out!

The Hammerhead (1-12, 2-10, 2-12 combos) is designed for early output tube overdrive using 2 EL-34s in a 25 watt push-pull cathode bias class A design with zero negative feedback. Mixing some vintage roots, the super-simple Hammerhead can go from tweedish clean to power tube crunch at medium sized club volumes. The controls are Volume, 4 position Impact (treble and upper mid emphasis), Master Volume, and 4 position Grip (preamp gain).

The Slant 6V (1-12, 2-12, 2-10, 1-15 combos and head) is a 40 watt 4 6V6 amp with one pair of 6V6s running cathode bias (smooth sustain and midrange thickness) and the other pair running Fixed bias (punch and headroom). Two selectable half power settings using either pair of tubes. The Slant 6V has two footswitchable independent channels - clean with reverb and Overdrive with two selectable gain settings. The 6V is at home with virtually any kind of music and on any stage. For the power hungry we make a double power version of the Slant 6V with 6L6 tubes putting out 80 watts in full power.

The Imperial (2-12, 1-15 or head) is the bigger brother of the Rambler, sporting 4 6L6s for 60 watts Pentode, 28 watts Triode Class A cathode bias and no negative feedback. It sounds very similar to the Rambler and also has a footswitchable variable boost.

*VTV: Who are some well-known players that use Carr amps (which amps do they use and who do they play with)?*

SC: CoCo Montoya (Solo artist), double power Slant 6V, Nils Lofgren (Bruce Springsteen + tons of session and solo work), double power Slant 6V. Buddy Miller (Emmylou Harris, Buddy and Julie Miller), Hammerhead. Mitch Easter (Lets Active and studio producer), Slant 6V and a Mercury. Michael Landau (massive session player) Slant 6V, Rambler, Mercury. Mark Goldenburg (Jackson Browne + session work), Rambler. Chris Leuzinger (Garth Brooks, session producer), Rambler, Danny Flowers (Nashville songwriter/session musician), Rambler, Slant 6V. Michael Thompson (huge session list), Slant 6V. Rick Miller (Southern Culture On The Skids), Slant 6V. Will McFarlane (Bonnie Raitt, Muscle Shoals session player), Rambler. Tony King (Brooks and Dunn), Slant 6V. Tom Anderson (Tom Anderson Guitar Works), Mercury.

**Carr Rambler Amplifier**

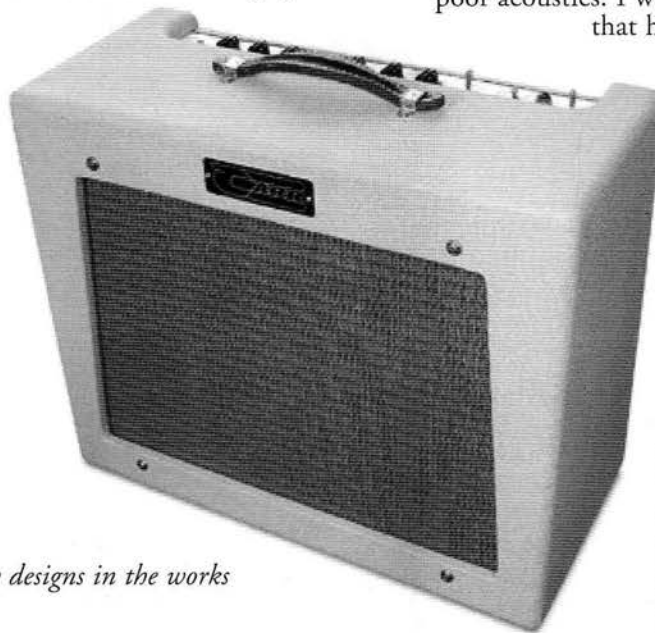

*VTV: Do you have any new designs in the works these days?*

SC: We are always coming up with new ideas to try. It is a long process though, developing a new model. Many great ideas on paper do not always sound the way you hope they will. So a lot of building and listening goes into each design.

I hesitate to offer my current projects because I am not sure if they will pan out just yet. That said, I hope to have a model based on multi channel Mercury technology in a 50-watt platform ready in a year or so - who knows, it may evolve into a bass amp - so I don't want to say too much!

*VTV: The boutique guitar amp business is getting a bit crowded these days. What do you think sets Carr amps apart from the other builders?*

SC: One early decision that has served us very well is to learn from the great designs of the past but not to copy them. I believe when people think of Carr Amplifiers they think of our amps as unique. Our amps are new

tools for creating the tones of the future, extending our sonic traditions without being bound to them.

More concretely, we are using cutting edge components and laborious construction techniques few companies are willing to invest in. Finally, we spend a great deal of time on the aesthetics of each model. I believe they should be as pleasing to look at as they are to play.

**Mini-Review of a Carr Rambler Amp by CK**

For a number of years, I played in a six-piece jump-blues band in the Mendocino and Lake County, California area called the Blues Factor. The venues in this area were varied, but most had small stages and poor acoustics. I was searching for a versatile amp that had exceptional tone, was light, sounded good and could get loud when necessary. I tried a number of old Fender amps including a Black-Faced 1969 Pro-Reverb Fender, Deluxe Reverbs, Mesa Boogies and a few others. They all did their thing well, but I was looking for something different.

The Carr Rambler is a 28 watt self-bias PP 6L6 amp that converts to a 14 watt triode amp with the flick of a switch. There is also an excellent reverb and a real tube-based tremolo circuit for added sweetness. The amp is completely hand-assembled and uses point-to-point wiring throughout. The amp also uses no electrolytics in the power supply. Instead, it has large Solen film caps to improve sonics and long-term reliability.

When I brought the Rambler to a band rehearsal, everyone in the band loved the tone, even our female lead vocalist! I play a custom Strat with Van Zandt Blues pickups as well as a Guild Starfire IV. These guitars both sounded musical and tuneful in the Rambler. The Rambler comes standard with a Kingpin 60 (Eminence) 12 inch speaker as well as other speaker combinations.

The Rambler is a versatile, light and great sounding amp that can rock out, play sweet blues leads, smooth jazz chords and just about everything in between. Sell your Deluxe Reverb! The Rambler can do what it does and more!

# Scott 299C, D and LK-72 Amplifiers

By Charlie Kittleson ©2003 All Rights Reserved

Just about the time the Space Race was getting into full swing in the late 1950s, stereo records and related stereo gear started to appear in hi-fi shops across the USA. While there were many mono holdouts that claimed stereo was just a way to sell more speakers and more expensive amplifiers, the impressive sound of two channel recordings was hard to resist for the average audio nut.

The majority of home electronic equipment manufacturers, including RCA, Philco, Fisher, EICO, Marantz, HH Scott, etc, introduced stereo amplifiers. Only a few of these are considered classics today, nearly fifty years later. Many other cheaper and cheesier units, wound up in the landfill after they were outmoded or needed significant service. The 1970s was the beginning of the now accepted "throw away" culture. When something got old, don't fix it, just throw it away and get a new one.

Fortunately for us, tube amps were built to last and are easily rebuildable. Most parts are now available to rebuild and service vintage tube amps, including 7591 tubes, reissue Mallory FP can-type electrolytics and 600 volt film caps, to name a few.

The amplifier designs of Daniel von Recklinghausen, head of engineering for HH Scott were some that are considered classics today. Von Recklinghausen designed Scott amps to make music realistic, not for cheap, like most of the audio gear today.

Transformers were made of high quality material, chassis were all metal. Aluminum was used because it is a better conductor of heat than steel, plus it is non-magnetic, so it does not carry induced hum from the power transformer. There was no scrimping on power supply decoupling or number of functions. All amps had separate stereo tone controls for bass and treble as well.

## Scott 299C

The need for more powerful stereo integrated amps became evident at the beginning of the Sixties. Fisher, EICO, HH Scott and others used the EL84/6BQ5 in almost all of their integrated amplifiers. While this tube sounded sweet and detailed, it did not generate the horsepower needed for AR, KLH and other bookshelf speakers of the day.

With the introduction of the 7591 by Westinghouse in early 1958, audio equipment manufacturers scrambled to design higher power stereo integrated amplifiers. One of the first tube stereo receivers to use the 7591 was the Fisher 800, introduced in late 1958. The 7591 was capable of generating between 25 and 30+ watts RMS with plate voltages in the mid-400V range. It was a tube that was physically the size of a 6V6GT, but was capable of more than double the power. This was due to superior metallurgy and precision manufacturing techniques. The 7591 was eventually used by Bell, Bogen, EICO, Fisher, Harman-Kardon, Madison-Fielding, McIntosh, Pilot, Sherwood, and many others.

Up until 1961, HH Scott used either EL84s or 7189s in their stereo integrated amplifiers. When the 7591-equipped 299C (\$230) was introduced for the 1962 model year, it was an instant success. Rated at "40 watts music waveform" per side (inflated), the 299C was a real music machine. The driver/phase inverter tubes used were the 6BL8 and in later versions, the 6U8. Phono stage and tone control tubes were four 12AX7 types, notably Telefunken ribbed plate in the original configuration.

Styling of the 299C was very similar to the 299B. An all metal, gold anodized aluminum faceplate with solid aluminum machined control knobs, also gold anodized, were used. The

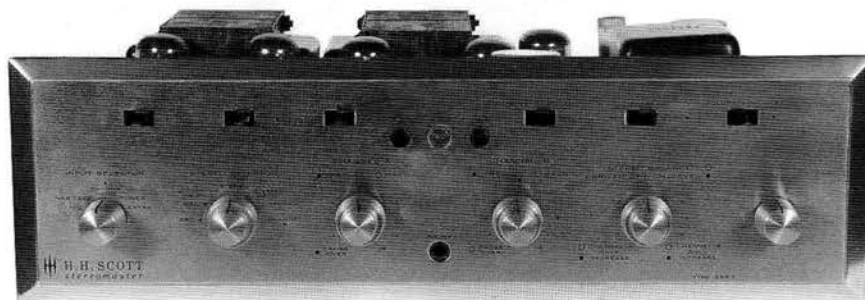

H. H. Scott 299C

chassis was also aluminum and the wiring was point-to-point. The power transformer was a TRA-13-3. Plate voltage was increased to about 445Vdc. The output transformer was upgraded to the huge and very superior TRA-11-2. The EIA code on the transformer indicates that it was made for HH Scott by Stancor. Daniel von Recklinghausen was responsible for the design of the output transformer. It is a legendary performer and has excellent response characteristics. John Atwood performed extensive PP transformer tests in 1990 and those tests indicated that the TRA-11-2 transformer was

capable of 35 watts RMS power with frequency response from 35Hz to about 66 kHz.

Interesting features on the 299C included four pairs of phono cartridge inputs ( 2 low-level and 2 high-level pairs), a stereo selector switch for Balance A, Balance B, Mono, Stereo, Stereo Reverse, Channel A and Channel B. It also featured a derived center channel level control and output jack for a center-channel power amp. This gave the music a fuller sound, especially when speakers were far apart. It made the "listening sweet spot" larger and also allowed for an extension speaker in another room.

A few years ago, *Rolling Stone Magazine* reviewed vintage tube equipment. The reviewer favored the Scott 299C and thought it was the best-sounding amp he had heard under \$2000. This started a small flurry of enthusiasts who began seeking nice 299Cs for their systems.

**Scott 299D**

Scott sold tens of thousands of 299Cs in late 1961 and throughout 1962. However, the champagne gold faceplate and styling was getting a little long in the tooth and needed to be changed. Scott had used the popular gold anodized aluminum faceplate and knobs for almost ten years and in order to keep up with the times, a decision was made to use a chrome plated cast aluminum edged faceplate with natural aluminum face and two-piece plastic and aluminum control knobs. Instead of red neon indicator lights, there were rectangular blue and white jeweled channel indicator lights on the front panel.

The new model was dubbed the 299D (\$235) and was made from late 1963 until the end of 1966, when the solid state 299F was introduced. Very few 299Fs survived, thanks to primitive output transistors with very high failure rates.

The chassis layout was also different on the 299D. The output tubes were located further from the output transformers, facilitating cooler operation. The 6U8A driver tubes were both

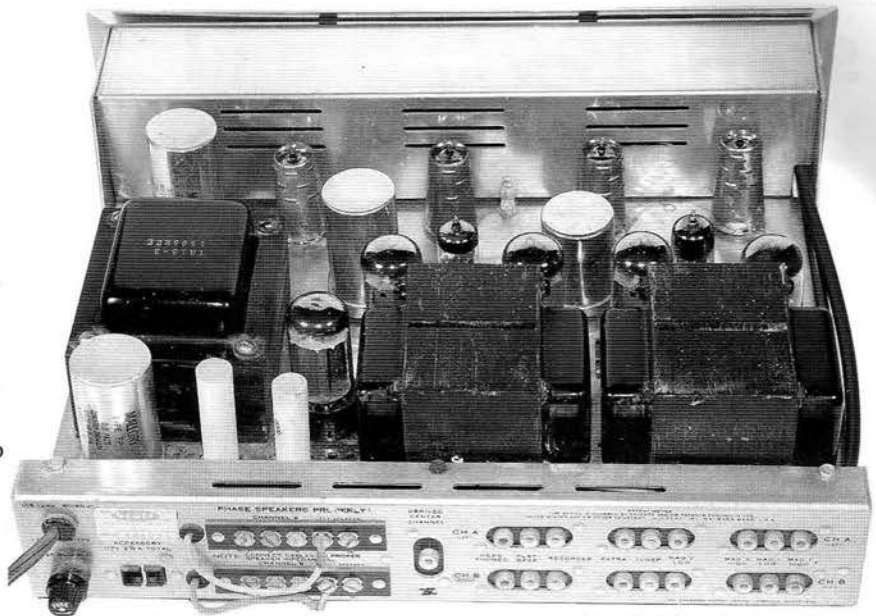

299C Chassis (rear)



299D

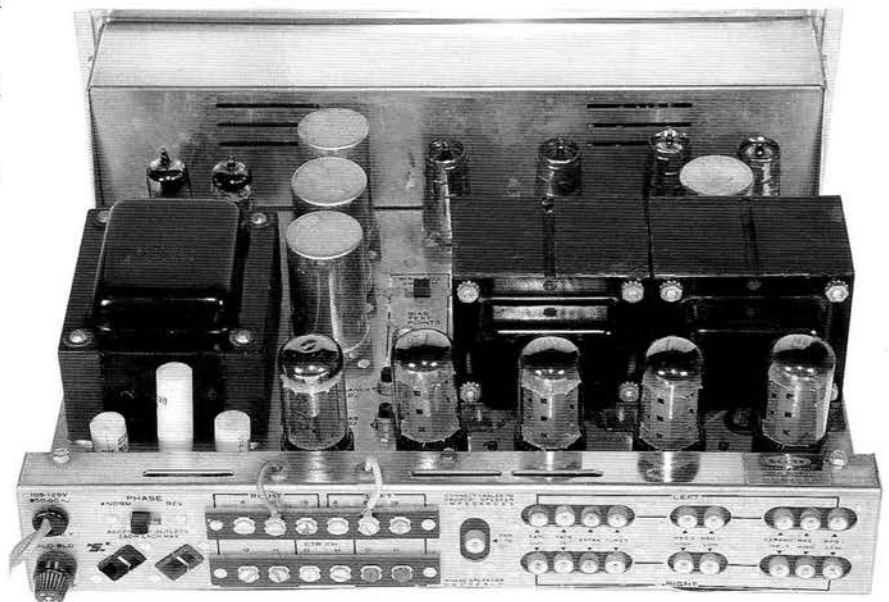

299D Chassis (rear)

located in the upper right hand corner of the chassis, away from the output tubes. Four 12AX7A Telefunken's were used in the phono stage and tone control circuits, all with DC on the filaments. The rectifier was a Mullard GZ34. There were finally separate bias and balance controls for each channel.

The output and power transformers were exactly the same as the 299C. No need to change a good thing. In all, I feel that the 299D is the most desirable of all the 7591 HH Scott amps. This is because the circuit was improved and simplified, bias adjustment was easier, the chassis layout was more efficient and it had more clearance between the output tube sockets and the sides of the output transformers. This allows you to use the newer 7591A EH Sovtek output tubes instead of the increasingly-rare NOS 7591s.

**Scott LK-72**

The tradition of building electronic kits goes back to the early wireless days before 1920. It continued through the early 1970s, but by then was considered too nerdy and not cool. Kit building and do-it-yourself audio projects are now becoming the in thing for hardcore audio freaks who want the best sound for the least money.

HH Scott developed a line of hi-fi kits during 1959-1960 for the growing enthusiast market who wanted to save a little cash by building their own amps and tuners. Scott apparently sold a lot of these kits, but the return on investment was not very good, according to Daniel Von Recklinghausen in a recent interview. A lot of time and money was spent on developing the color-coded, step-by-step assembly manuals and the specialized kit packaging.

The LK-72 (\$160 kit, \$250 wired) was the most popular of all the Scott kits. It was available with either a light gold anodized faceplate and brown bakelite knobs or the very dark brown faceplate with similar knobs. Tone controls for bass and treble were not concentric like on the 299C, but were separate knobs. Output and power transformers were the same as the 299C. Tube complement was basically the same, although the early versions used the 7199 as the driver tube instead of the 6BL8/6GH8.

Factory power ratings for the LK-72 were 36 watts

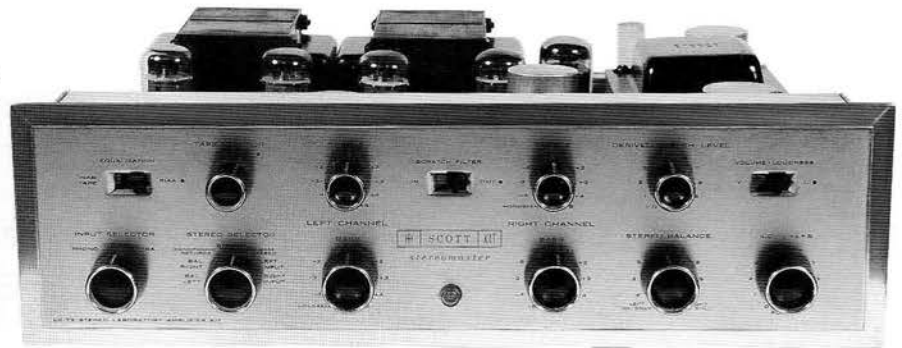

LK-72

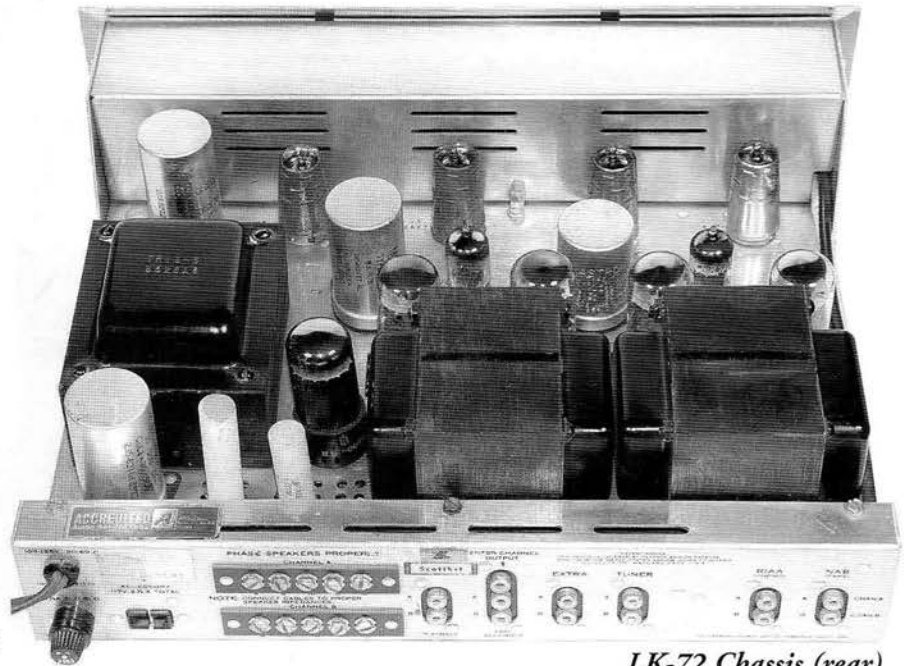

LK-72 Chassis (rear)

per channel at 1000 Hz with .8% distortion. Since most listeners prefer to listen at levels less than 5 watts, they claimed total harmonic distortion was less than .05%!

The circuit was little simpler than the 299C. There was only one set of phono inputs and one pilot light instead of the three function lights on the 299C. There were also fewer functions and switches. The LK72 did include a combined center channel output that was used as a subwoofer out or as a third or center channel using a separate mono amp and speaker.

**Scott LK-72B**

In the fall of 1962, the styling for the LK-72B (\$150) changed to become similar to the 299D. The chassis layout was improved and allowed for more clearance for the output tubes. A headphone jack was added to the front panel. Tube complement was standardized to: a quad of 7591s, four 12AX7As, two 6U8As, and a GZ34. It had less features than the 299D, such as fewer phono inputs and two less indicator lights on the faceplate. Power and output transformers were identical to

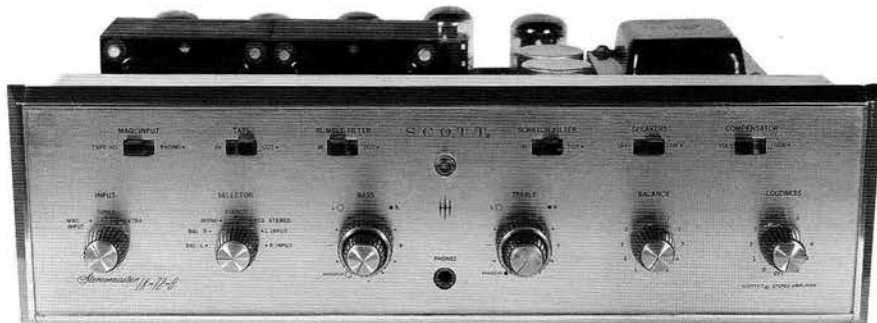

LK-72-B



LK-72-B Chassis (rear)

the 299D, as were factory power ratings of 40 watts per channel.

### Scott 233

The Scott 233 (\$190), was made from 1964 through 1966. It had similar features to the Scott LK48, but used 7591 output tubes. The factory power rating was less at 33 watts music waveform and the output transformers were noticeably smaller. The power transformer was the TRA-13-3-4 and the output transformers were TRA-8-5-4.

There were even fewer features than the LK-72B and the circuit was slightly different. Tube complement was identical to the other amps, but interestingly, the plate voltage on the 7591s was 456V, same as the LK-72B.

### How do they Sound?

Any of the amps mentioned in this article will blow away modern solid state amps from a musicality standpoint. They are dynamic, sweet, musical, three-dimensional and life-like. By comparison, most solid state amps may have stronger bass, but that's probably the

only advantage. Stereo on tubes is 3-D, while transistor is flat and lifeless. Even five or six channels can't rescue it.

### How to Buy a Scott Vintage Amp

Between 100,000 and 150,000 HH Scott stereo integrated tube amplifiers were made from 1959 through 1966. Some models are easier to find than others. LK-72s seem to be the most common, with 299Cs the next most common. LK-72Bs and 299Ds are next with the 233 being probably the lowest production of the lot.

Finding any of these amps is not a challenge. They are all over Internet auction sites, ranging in price from about \$150 for a good one to over \$800+ for mint, fully restored ones. If you buy from an auction site, be sure the amp works and the seller is knowledgeable about what he is selling. Make sure he carefully double-boxes the amp and insures it.

It is also possible to find these amps at yard sales, flea markets, amateur radio swap meets, antique radio events, etc.

### Rebuilding and Restoration of a Scott Amp

*Tech Note: Do NOT plug a 40+ year old amp into 120VAC without "forming" the caps on a Variac over several minutes. Otherwise you could blow the power transformer-which can't be replaced easily.*

For maximum performance and reliability, Scott tube amps should be rebuilt and fully restored. First, the unit should be dusted and cleaned off. Be careful not to use alcohol solvents on any area that has printed lettering. This includes the faceplate, chassis lettering, etc. To clean faceplates, first remove them from the main chassis. The best cleaner I have found for aluminum anodized faceplates is call S-1. It is usually available in motorcycle shops and comes in a large spray bottle. It can be sprayed directly on the faceplate and then rinsed off with warm water. Use your fingers to rub off any grime or dirt, never use much pressure and never let the S-1 soak in for more than a few minutes or it will take the lettering off the faceplate.

All tube sockets, switches and controls should be cleaned with safe and environmentally-friendly parts cleaners. All signal, coupling and bypass film caps should be replaced. We have found that Illinois



Capacitor ICMWR metallized polypropylene sounds the best in vintage tube amps. This is due to the fact that they are not ultra-fast and sound a little warmer than expensive, boutique types. Most of the high voltage can-type multi-section electrolytic capacitors can be replaced with newly manufactured ones available from CE Distribution in Tempe, Arizona. The lower voltage ones, under 450 volts, must be replaced with smaller, under-chassis axial electrolytics such as Illinois Capacitor or Sprague Atoms.

Plate, cathode, bias, phase inverter and other key resistors should be replaced with modern 1-5% tolerance one or two watt resistors for lowest noise and best sound. Carbon or metal oxide film work well, but are not as warm as the original carbon composition. Often, the "chalk stick" power resistors at the back of the chassis are broken. These are not available anymore and must be replaced with modern ceramic or aluminum power resistors.

These amps originally came with Telefunken 12AX7s. Usually, they are still good, as this tube was reportedly made to last up to 100,000 hours. If your Teles are missing or defective, good NOS subs are GE or RCA 12AX7s. I have found that Sovtek 12AX7EHs work well in Scott amps too.

Modern production 7199s can be problematic. Good 7199s are the key to proper phase inverter balance and low distortion. It is best to use NOS 7199s, preferably Sylvania or RCA, as they seem to sound the best and last the longest. 6U8s and 6GH8s are fairly cheap and easy to find currently. Recommended brands are Telefunken, Amperex, Sylvania, RCA or GE. Some of the late production JAN/Philips 6U8s and 6GH8s can have quality issues, so be sure to check them on a good tester before installing them.

New Sensor/Electro-Harmonix has been producing a good quality 7591A direct replacement for a few years now. It is physically based on their popular 5881 tube and is the exact same size. Obviously the tube pinout and grid wire pitches have been changed to match the specification of the NOS 7591s. The only issue with

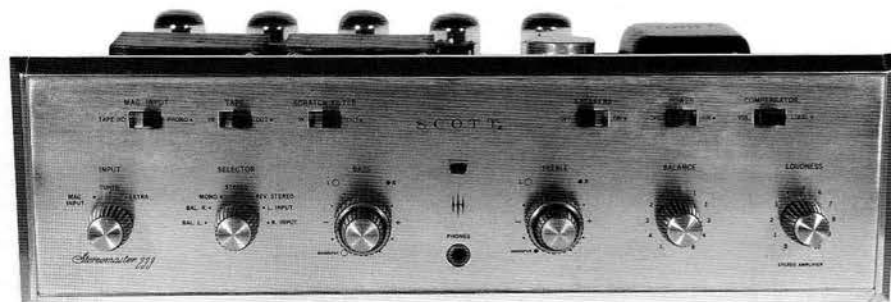

Scott 233



Scott 233 Chassis (rear)

the New Sensor 7591As is their outside diameter, which is almost .125+ inch larger than an NOS 7591A. They barely fit in the 299C and LK-72, and come very close to and even touch the output transformers. This is not a problem on the 299D or LK-72B, which has more distance between the tube socket and the output transformer.

In most cases, the original Mullard GZ34 found in these amps still tests good. If yours is defective, the new JJ GZ34 is an excellent tube and sounds fantastic. Be careful when buying new and NOS tubes from Internet auction sites. Make sure the seller has a high quality tube tester, guarantees the tubes to be good and has a good return policy if tubes are defective.

**Acknowledgements**

Many thanks to Daniel von Recklinghausen, Earl Yarrow, John Eckland, and Lee Schuster with his informative [www.hhscott.com](http://www.hhscott.com) site.

**LEFT CHANNEL**

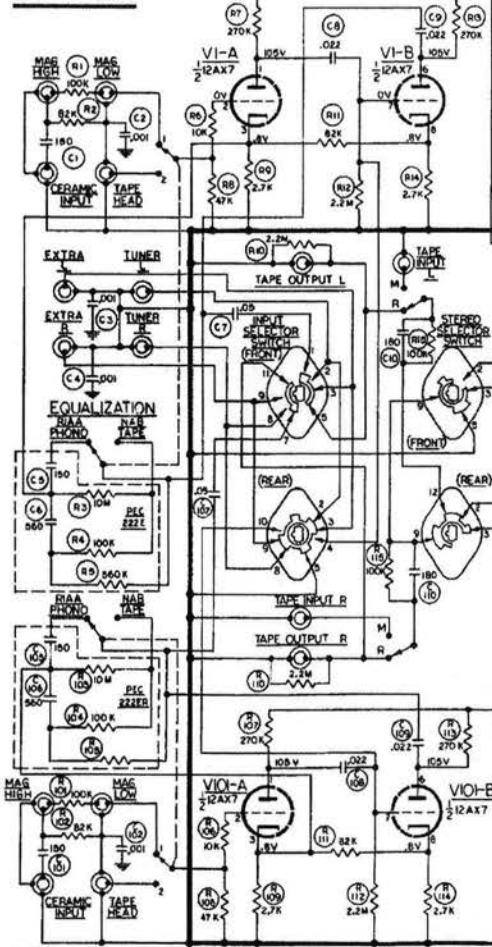

**RIGHT CHANNEL**

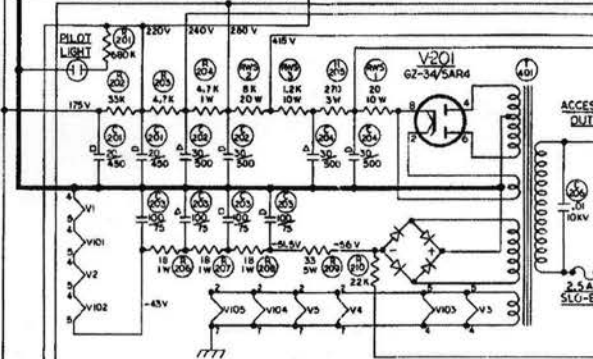
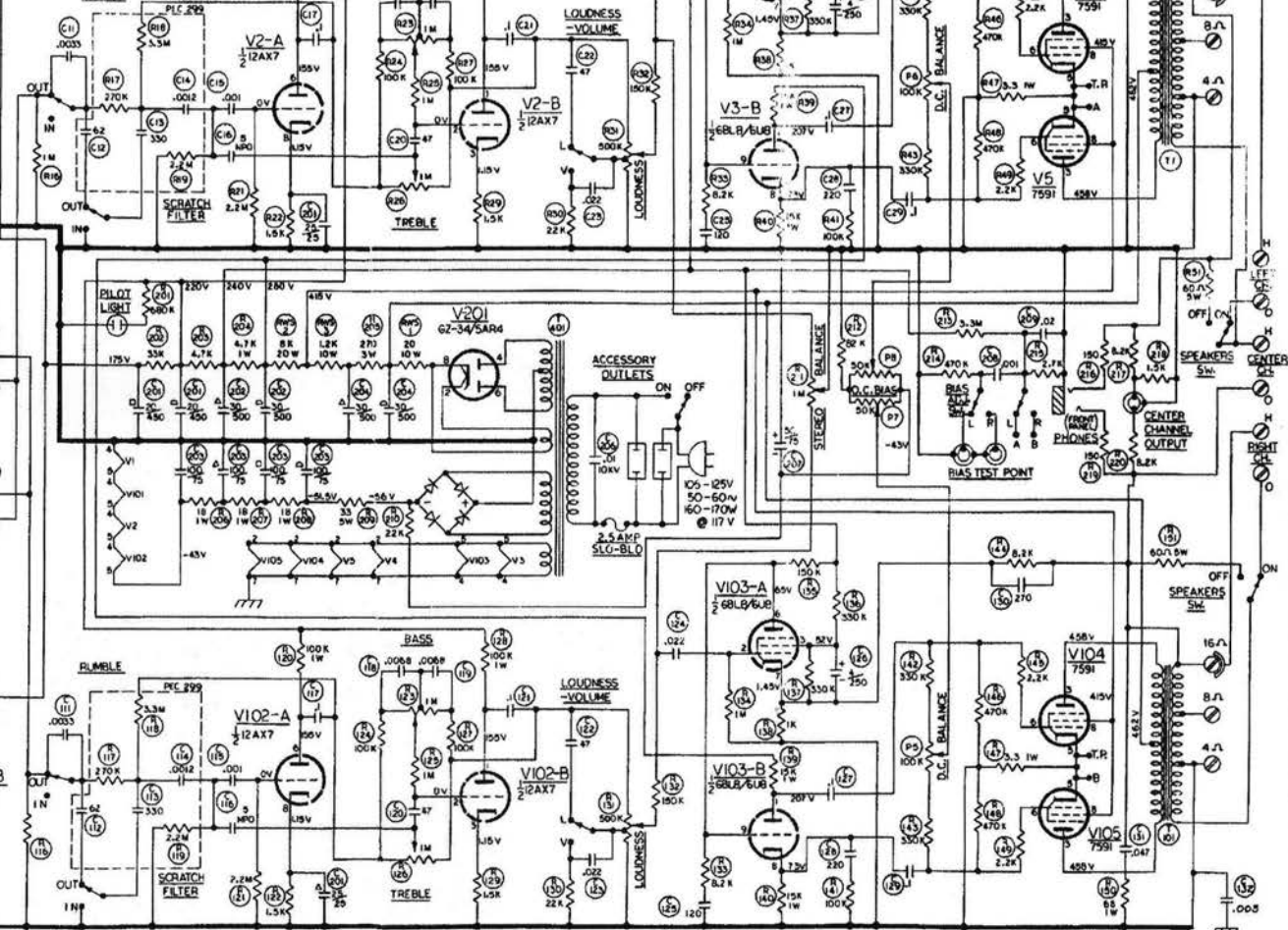

**INPUT SELECTOR**  
 POSITION      FUNCTION  
 1      PHONO  
 2      TUNER  
 3      EXTRA

**STEREO SELECTOR SW.**  
 POSITION      FUNCTION  
 1      BALANCE L  
 2      BALANCE R  
 3      MONOPHONIC RECORDS  
 4      STEREO  
 5      REVERSE STEREO  
 6      LEFT INPUT  
 7      RIGHT INPUT

**EQUALIZATION SW.**  
 POSITION      FUNCTION  
 1      N1A-NAR1B-ORTHO  
 2      NAB TAPE

THE FOLLOWING CONTROLS IN LEFT CHANNEL ARE MECHANICALLY GANGED WITH IDENTICAL CONTROLS IN RIGHT CHANNEL  
 1-INPUT SELECTOR  
 2-SCRATCH FILTER  
 3-RUMBLE FILTER  
 4-LOUDNESS AND POWER SW.  
 5-SPEAKER SW.

SCALE:	TYPE LK72B CIRCUIT DIAGRAM 8-28-63
H. H. SCOTT, INC. MAYNARD, MASS., U. S. A.	
DR. A. R. RAMOS	ENG. P. C.
CH	PROD. P. C. NO. D-LK72B-C1 808/O

*Mercury*



*Imperial*



*Slant 6V*



*Hammerhead*



*Rambler*

*Amped!*

**CARR**  
**AMPLIFIERS**

www.carramps.com 919.545.0747

# VTV Pro Tube Shop

PO Box 1499

Lakeport, CA 95453 USA

www.vacuumtube.com 707-263-5881 Phone 707-263-7648 FAX

## New Production Tubes

6L6GC JJ Matched Pair \$38  
 6L6GC JJ Matched Quad \$76  
 6L6GC Svetlana M/Quad \$74  
 6SN7WGTB JAN/Sylvania \$35  
 6V6GT EH Sovtek M/Pair \$20  
 12AT7JJ \$12 ea  
 12AX7 Chinese \$12 ea  
 12AX7 NOS Chinese 1991 \$16 ea  
 12AX7 Ei (flat plate) \$9.95 ea  
 12AX7LP Sovtek \$7.50 ea  
 12AX7LPS Sovtek \$7.95 ea  
 12AX7EH Sovtek \$12.95 ea  
 12AX7 JJ \$8.95 ea (original style)  
 12AX7S JJ \$15 ea (spiral filament)  
 EL84 JJ Matched Quad \$50  
 EL34 Svetlana Matched Pair \$40  
 EL34 Svetlana Matched Quad \$79  
 E34L JJ Matched Pair \$38  
 E34L JJ Matched Quad \$75  
 6550C Svetlana M/Pair \$60  
 6550C Svetlana M/Quad \$115  
 6922 JJ \$18 ea (\$40 M/Pair) (low noise)  
 6922 Sovtek \$14 ea (\$35 M/Pair)  
 7591A EH Matched Pair \$43  
 7591A EH Matched Quad \$85  
 KT66 Chinese Matched Pair \$67  
 KT88 Golden Dragon \$165-M/quad  
 KT88 JJ Matched Quad \$185  
 KT90 Ei Matched Pair \$85  
 KT90 Ei Matched Quad \$175

## \*NOS Audio Tube Treasures

GE 5U4GB 1960s \$25  
 Mullard EL84 1970s \$150 Match/Pr.  
 Mullard CV4003/12AU7 Box PI \$45  
 1970s Mullard E88CC/6DJ8 \$50  
 1970s Tungram E88CC/6DJ8 \$45  
 12AX7WA GE \$35 ea  
 12AX7A RCA 1960s \$55 ea  
 5814/12AU7 JAN \$15  
 7868 GE Matched Pair \$120  
 1970sTelefunken ECC81/12AT7 \$59  
 1963 Westinghouse 6V6GTA \$50  
 1972 Siemens 5814A/12AU7 \$38  
 1960s GE 6072A Black Plate \$40  
 RCA Black Plate 6SN7GTB \$60 ea

\*(limited stock on hand-act now)

## Auricaps - The Best Sounding

Signal Capacitor We Know Of  
 Super-High Quality with color-coded  
 tinned leads. Polypropylene and Foil

.01uf@600V	\$4.75 ea
.02uf@600V	\$5.05
.047uf@600V	\$5.75
.1uf@600V	\$8.75
.22uf@600V	\$10.25
.47@600V	\$14.25
1.0uf@450V	\$8.95

## High Voltage Electrolytic FP Can Capacitors

20,20,20,20uf@475V	\$36 ea
40,20,20,20uf@525V	\$48 ea
80,40,30,20uf@525V	\$51 ea
330uf@450V/clamp	\$20 ea (PC mt)

## Illinois Capacitor ICMWR

*Vintage-Sounding Metallized*

*Polypropylene Signal Caps*

## The Best-Sounding Capacitor and for Vintage Tube Hi-Fi

.001uf@630V	\$0.90 ea
.0022uf@630V	\$0.90
.0033uf@630V	\$0.90
.0047uf@630V	\$0.90
.0068uf@630V	\$0.90
.01uf@630V	\$1.00
.015uf@630V	\$1.25
.022uf@630V	\$1.10
.033uf@630V	\$1.20
.047uf@400V	\$1.20
.047uf@630V	\$1.25
.068uf@630V	\$1.35
.1uf@400V	\$1.25
.1uf@630V	\$1.40
.22uf@400V	\$1.50
.22uf@630V	\$2.00
.47uf@630V	\$2.50
1.0uf@400V	\$3.50
2.2uf@400V	\$3.75
3.3uf@250V	\$4.00
4.7uf@250V	\$4.50

## Illinois Capacitor Axial Electrolytic Capacitors

Great Value and Very Dependable

3.3uf@350V	\$1.20
4.7uf@350V	\$1.45
10uf@160V	\$1.25
10uf@450V	\$1.60
22uf@50V	\$0.85
22uf@450V	\$2.50
47uf@50V	\$1.00
47uf@350V	\$2.50
47uf@450V	\$3.50
100uf@100V	\$1.65
100uf@160V	\$2.50
100uf@340V	\$3.75
100uf@450V	\$4.50

## Sprague Atom Axial Electrolytics

Made in USA Highest Quality

20uf@500V	\$3.95
20uf@250V	\$1.85
50uf@50V	\$1.25
40uf@450V	\$4.75
40uf@500V	\$6.75
100uf@100V	\$2.00
100uf@150V	\$2.95
100uf@350V	\$5.00

## Tube Sockets

9 pin NOS Micanol PC Mount	\$4.50 ea
9 Pin Ceramic Chassis Mount	\$2.50 ea
9 Pin Ceramic Chassis Mount	\$2.00 ea
Octal NOS Micanol Chassis Mt	\$4.50 ea
Octal Ceramic Chassis Mount	\$3.00 ea
Octal Ceramic PC Mount	\$2.50 ea

**90 Day Warranty on All Tubes**  
**American Express, Master Card**  
**and VISA Credit Cards Accepted**  
**Shipping and handling extra**

**Call or Log in to our website for  
 24 hour automated ordering.**

**707-263-5881**

**www.vacuumtube.com**

**World-Class Audio  
Discount Prices**

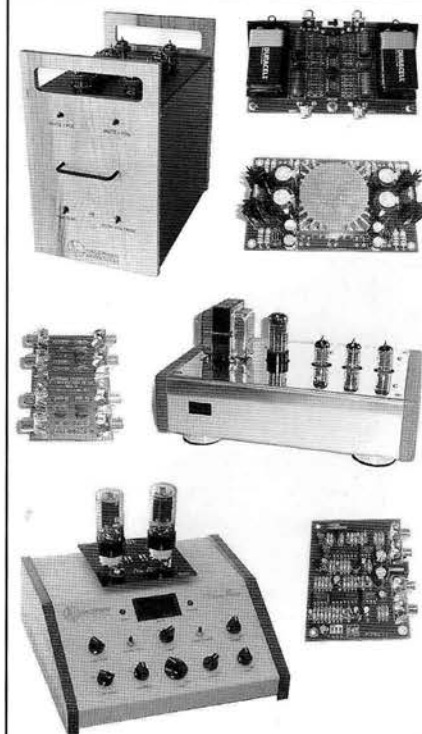

[www.hagtech.com](http://www.hagtech.com)

Vintage NOS Audio and  
Guitar Tubes  
**New Lower Prices!**



One of the largest selections of genuine, tested, premium grade NOS audio tubes for sale:

5U4GB	5AR4	6CA7	6L6GC
6SL7GT	6SN7GT	6V6GT	12AT7
12AU7	12AX7A	45	50
807	811	5687	5881
6201	6550A	6681	6922
7308	7355	7581	7591
7868	8417	EF86	EL34
EL84	396A	417A	KT66
KT77	KT88	KT90	MORE!

[www.vacuumtube.com](http://www.vacuumtube.com)

**(707) 263-5881**

Check our website for new items and lower prices



**Omega Speaker Systems**

High Efficiency Single Driver Loudspeakers

*Perfect for all Amplifiers*

Prices start at \$399/Pair / 7 Standard finishes  
Handcrafted in Norwalk, CT. U.S.A. 203-847-2800

Dealer program available / 10 Year Warranty  
[www.omegaloudspeakers.com](http://www.omegaloudspeakers.com)

**Super 3**

*Electrostatic Speed, Transparency, Seamlessness with  
High Sensitivity and Dynamics. Prices start at \$529/Pair.*

**SILVER SONIC™**

Audio Cables

*Making the High End  
Affordable!*

"With tube amps and hybrids, the  
Silver Sonic competed with the best."  
*Bound for Sound*

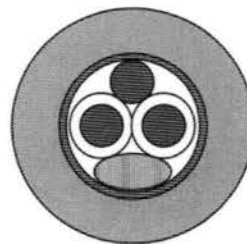

Silver Sonic T-14 Speaker Cable  
Silver Sonic BL-1 Series II Interconnect  
Silver Sonic D-110 AES/EBU Digital  
Silver Sonic D-75 Digital Cable  
Hook up wire & Connectors

D.H. Labs, Inc.  
612 N. Orange Ave., Suite A-2  
Jupiter, FL 33458  
(561) 745-6406 (phone/fax)  
[www.silversonic.com](http://www.silversonic.com)

# VTV Dual Triode Characterizer

## The Best Tester *Ever* For Preamp Tubes!

**List Price \$945 - Audiophile/Tech Price \$749**



### Dual Triode Preamp Vacuum Tube Characterizer

Finally, an instrument-grade audio preamp tube tester for OEMs, tube dealers, audio techs and guitarists/audio enthusiasts. This valuable tool allows you to accurately test and grade new and old/used dual triode audio tubes. Our instrument performs tests on audio tubes that are not possible with Hickock and other radio/TV tube testers. It features a built-in four inch speaker and headphone jack so you can actually listen to the tube being tested for noise and microphonics. In addition, it tests for gain on both medium and high-mu types, triode balance and shorts. You can quickly check both triodes with the flick of a switch. This money-saving device is just what the doctor ordered for premium grading of audio tubes.

**Controls/Features:** Calibrated dual red illuminated meter (indicates gain and triode balance); toggle switches for power, 6/12 volt filaments, tube type selector, triode in test; rotary switch for high and medium mu, push-button for triode balance, volume control for audio output, high-quality NOS Micanol tube socket, BNC output for scope or distortion analyzer, four-inch internal speaker and headphone jack. It is housed in a sturdy, die-cast 3/16 inch thick metal enclosure.

**Tests the following dual triode preamp tubes:** 6CG7, 6FQ7, 6DJ8, 6922, E88CC, 7308, E188CC, 6SN7GT, VT-231, 5692, 6SL7GT, 12AT7, ECC81, 12AU7, ECC82, 5814, 12AX7, ECC83, 5751, 12SN7, 12SL7, etc.

\*Optional octal socket adapter and 9-pin socket saver are available for an additional **\$60**.

\*90 to 250V AC Universal Adapter with applicable plug for European or Asian Voltages additional **\$60 extra**

**Available exclusively from: Vacuum Tube Valley, PO Box 1499,  
Lakeport, CA 95453 USA**

**707-263-5881 phone - 707-263-7648 FAX [www.vacuumtube.com](http://www.vacuumtube.com)**

## Vintage Hi-Fi Equipment for Sale

Altec, Bell, Dynaco, Eico,  
Fisher, Harman-Kardon,  
McIntosh, Marantz, Pilot,  
Scott, Stromberg-Carlson, etc.  
*Power Amps, Preamps,  
Tuners, Receivers, Speakers,  
Crossovers, etc.*

Completely stock and original  
or fully restored, your choice.  
Our reputation for quality vin-  
tage hi-fi is the one of the  
best in the world!

*Check our website for  
the latest in cool vintage  
audio gear.*

Charlie Kittleson  
PO Box 27  
Lakeport, CA 95453 USA  
707-263-5881  
[www.vacuumtube.com](http://www.vacuumtube.com)

## ELECTRA-PRINT AUDIO

### Quality Handwound S.E. Output Transformers

- Primaries from 1.8K to 10K
- Exclusive wideband design
- Line Stage with Headphone Out
- Single Plate to PP Grids

### Custom-Built Power Transformers / Chokes

- Wound to your requirements
- Heavy-duty design for Class A use
- DC Filament Supply Windings
- HV chokes to 15H, 300ma
- Low voltage, high current filament chokes

Component Pricing and Specifications  
Catalog Available



**ELECTRA-PRINT  
AUDIO**

4117 Roxanne Drive  
Las Vegas, NV 89108

702-396-4909 FAX 702-396-4910



WELBORNE  
Laboratories

DIRECT REACTANCE DRIVE

45, 2A3 and 300B Versions  
SET Monoblock Design  
Kit or Assembled  
Prices Start at \$900



DRD45

[www.welbornelabs.com](http://www.welbornelabs.com)

www.AUDIOCLASSICS.com

Buy - Sell - Trade - Save

High End Audio - Home Theater Systems

featuring products by: McIntosh, Krell, Sunfire, Marantz, Elite, Tannoy, Audio Research, Lexicon, Cary, Cardas, VPI, Sharp, JBL, Mirage, Bryston, conrad-johnson, New Castle, B&K, Audio Control, Acurus, Aragon, Thiel & more.

3501 Old Vestal Road, Vestal, NY 13850  
607-766-3501

www.StereoFactoryOutlet.com

Save on Refurbished and Discontinued AV components.

Kara Chaffee  
**Hickok**  
Cloverdale, CA.

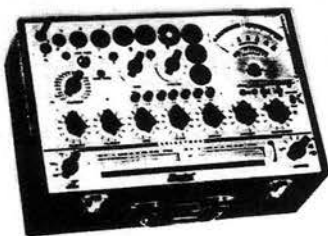

- Repair & calibration from 532 to Cardmatics
- **Hickok** testers for sale cleaned & calibrated with 90 day warranty
- Triplet 3444 repair
- We buy busted **Hickoks** too.
- See photos of all our testers for sale at:  
[www.Tubewizard.com](http://www.Tubewizard.com)  
email: [6SN7@abac.com](mailto:6SN7@abac.com)  
Phone : (707) 894-0176

9)one electron

Single-Ended Output Transformers

High Quality for a Reasonable Price  
Designed and Built in the USA



**UBT-1**

Designed for parallel operation of:  
2A3s, EL34s, 300Bs, 6AS7s, etc. or  
Sweep-tube in "enhanced triode" mode  
1.6k primary  
15 watts  
160mA

\$99.00

**UBT-2**

Can be used with:  
300B, 50, 5V811-3, etc.  
4.8k primary  
15 watts  
110mA

\$119.00

**UBT-3**

Good for single ended:  
2A3 or 300B  
3k primary  
15 watts  
110mA

\$99.00

**BFT-1B**

Designed for use with UBT-1s  
770vct / 520vct @ 340 ma  
6.3vct @ 9.6a  
6.3v @ 4a  
5vct @ 4a

\$169.00

quantity pricing available

**P-RC-1 and P-RC-2 Audio Chokes**

Designed for shunt-feed single-ended output applications, but are also useful where quality inductive loads are needed or as high-quality filter chokes. They have the same overall dimensions and use the same high-quality M6 laminations as the UBT transformers. Each have two identical windings, allowing series and parallel combinations.

6221 S Maple Avenue Tempe, AZ 85283  
ph: 480.820.5411 fax: 480.820.4643 or  
1-800-706-6789 e-mail: [info@tubesandmore.com](mailto:info@tubesandmore.com)  
[www.tubesandmore.com](http://www.tubesandmore.com)

TUBE AMP BOOKS  
by Kevin O'Connor

Books boutique amp builders rely on:

THE ULTIMATE TONE - US \$55  
Modifying and Custom Building  
Tube Guitar Amps

THE ULTIMATE TONE - Volume 2  
Systems Approach to  
Stage Sound Nirvana US \$40

TONNES OF TONE - US \$25  
Electronic Projects for Guitar & Bass

The hifi hobbyist's reference:

PRINCIPLES OF POWER - US \$35  
A Practical Guide to Tube Power  
Amplifier Design

READY SET GO! - US \$20  
An Electronics Reference for  
the Everyman

SHIPPING: US add 5% surface or 10% air  
Int'l: add 10% surface or 40% air  
MC, VISA, cheque or money order

POWER PRESS PUBLISHING

PO Box 1777, Station B,  
London, Ontario, CANADA, N6A 5H9

Phone 519-668-3132 FAX 519-668-2055



# Purveyors of "Classic" Transformers & Enclosures



*Single Ended, Push-Pull  
and Potted Tube Output  
Transformers*

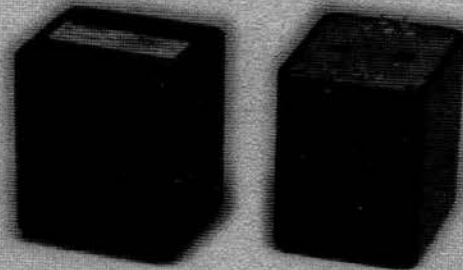

*Filter Chokes*

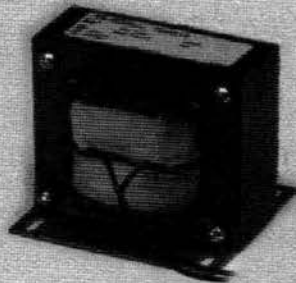

*Open & Enclosed  
Filament Transformers*

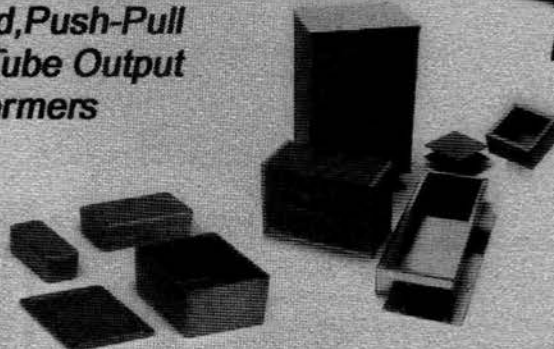

*Aluminum & Steel Chassis  
and Diecast Aluminum  
Enclosures*



*High Voltage Plate  
Transformers*



*Contact us for a free catalog & list of stocking distributors*



# HAMMOND MANUFACTURING™

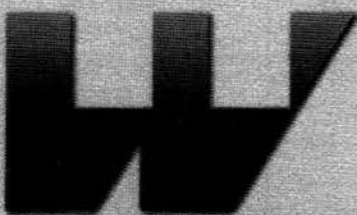

256 Sonwil Dr. - Cheektowaga, NY 14225 USA  
Phone: (716) 651-0086 Fax: (716) 651-0726  
394 Edinburgh Rd., N. - Guelph, Ontario N1H 1E5 Canada  
Phone: (519) 822-2960 Fax: (519) 822-0715

[www.hammondmfg.com](http://www.hammondmfg.com)

# VACUUM TUBE VALLEY

**"The finest tube-only magazine on the planet"**

Ken Kessler - Hi Fi News and Record Review - June 2000



**VTV #1 Spring 1995 \$15**  
Vintage Dynaco Tube Equipment - 1955-77  
History and Testing of the 12AX7/ECC83 dual triode  
Tube Testing Methods + Why Tubes Sound Better

**VTV #2 Fall 1995 \$15**  
Heathkit - The Tube Williamson Years 1950-61  
EL34/6CA7 History, Types and Tests  
Magnum SE EL509 Amplifier Project by Dave Wolze  
1927-34 Western Electric Theater Sound Systems

**VTV #3 Winter 1995/96 \$15**  
Eico Mono Tube Gear - 1955-62  
Altec Lansing 604 Coaxial Loudspeaker History  
Western Electric 300B History and Listening Tests  
300B SE Transformer Listening Tests

**VTV #4 Spring 1996 \$15**  
6L6 History, Types and Listening Tests  
Vintage Bookshelf Speakers 1955-1965  
Early FM Broadcasting History  
HK Citation I & II Amplifier History and Mods

**VTV #5 Fall 1996 \$15**  
The Ultimate FM Tuner Shoot Out  
Red Bank Guided Missile Tubes for Hi-Fi  
The Birth of the Marantz 10B  
Choosing Rectifier Tubes for your Guitar Amplifier

**VTV #6 Winter 1997 \$15**  
Fisher 500 - History, Models and Restoration  
A Tribute to Avery Fisher by the Fisher Doctor  
6550 and KT88 History, Types and Listening Tests  
Loftin-White Amplifier History by Alan Douglas

**VTV #7 Summer 1997 \$15**  
6DJ8, 6922 and 7308 - History and Tests  
Altec 1950s Theater Amps and Modifications  
The Great Voice - Peter Jensen Story  
Multi-Tube Line Stage Project - Eric Barbour  
Uncle Eric's Tube Dumpster - 417A/5842

**VTV #8 Fall 1997 \$15**  
EL84 History, Types & Listening Tests  
RCA Tube Mfg at Harrison, New Jersey  
200 watt OTL Amp Project by Allan Kimmel  
300B Listening Tests: NOS and Vintage Types  
Interview with Bruce Moore, Tube Audio Pioneer



**VTV #9 Spring 1998 \$15 (photocopy only)**  
Transmitting Tube Review, Ampeg SVT Guitar Amp, Altec 287W amp, Bargain Vintage Hi-Fi

**VTV #10 Summer/Fall 1998 \$15**  
Story of the 6V6 and listening tests, Hi-Fi radio in the 30s, PP SV572 amp, Ultrathin Line Stage

**VTV #11 Spring 1999 \$15**  
6SN7: History and Tests, Octal Line Stage Project, Mid-Priced Vintage High-Fi, OTL Headphone Amp, Capacitors and FREDs

**VTV #12 Summer 1999 \$15**  
2A3 History and Tests, 2A3 Amp Reviews, Bookshelf Speaker Test, Scott 299: History and Mods, 300 Watt SV572 Amp Project

**VTV#13 Winter 2000 \$15**  
6L6 Shootout, Paul Klipsch Interview, Klipschorn Lore and Mods, Scott 222 and LK-48, PP 2A3 Amp Project

**VTV #14 Summer 2000 \$15**  
12AX7 History and Tests (Guitar Amp Shootout) Elliano's Direct Reactance Preamp Project David Hafler - The Acrosound Years

**VTV# 15 Winter 2001 \$15**  
The 45 Triode - History and Tests RF-Powered Parallel Feed Amp Project David Hafler - The Dynaco Years 12AX7 Hi-Fi Shootout

**VTV# 16 Spring 2001 \$15**  
The EL34 Complete History and Tests Ultra-Path Parallel Feed Amps Dating Philips Tubes and More

**VTV #17 Fall 2001 \$15**  
Rectifier Tubes For Audio 6SN7 Line Stage Project Tube Amp Safety and More

**VTV #18 Spring 2002 \$15**  
Magic Eye Tubes, Rudy Bozak, Fisher FM100 Tuners, NOS Tube Investments, etc

## VTV Subscription Rates

4 Issues / Year  
\$55/year US First Class  
\$45/year US Third Class  
\$60/Canada-\$70/Europe  
\$75/Asia & World  
Back Issue Orders add \$3.50  
ea for US orders, \$9.00 ea  
Foreign and \$4.00 ea Canada

## VTV Subscription and Back Issue Order Form (FAX or Mail)

Name \_\_\_\_\_  
Address \_\_\_\_\_  
City \_\_\_\_\_ State/Country \_\_\_\_\_  
MailCode/ZIP \_\_\_\_\_ Telephone# \_\_\_\_\_  
I want to subscribe for \_\_\_\_ Years - Payment Encl. \_\_\_\_\_  
Send Me the following back issues \_\_\_\_\_  
Payment Enclosed (including shipping) \_\_\_\_\_

## VACUUM TUBE VALLEY

P.O. Box 1499  
Lakeport, CA 95453 USA  
Phone (707) 263-5881  
FAX (707) 263-7648  
email - triode@vacuumtube.com

Visit our on-line Pro-Tube Shop for the best selection of gourmet NOS audio tubes, quality tube amplifiers and more.

[www.vacuumtube.com](http://www.vacuumtube.com)

# PIONEER

ON MARCH 9, 2004 PAUL W. KLIPSCH WOULD HAVE BEEN 100 YEARS YOUNG. HIS LEGACY WILL LIVE ON FOREVER!

"HAPPY BIRTHDAY PAUL. I LOVE YOU. YOU ARE MY EVERYTHING."

-VALERIE

PAUL WILBUR KLIPSCH  
MARCH 9, 1904 - MAY 5, 2003

"LOOKING BACK HAS BEEN PLEASURABLE BUT THE CHALLENGE IS STILL TO LOOK FORWARD."

PAUL WILBUR KLIPSCH: THE LIFE... THE LEGEND  
[THE ONLY AUTHORIZED BIOGRAPHY OF P.W.K.]

DESIGN BY MARCO PROZZO

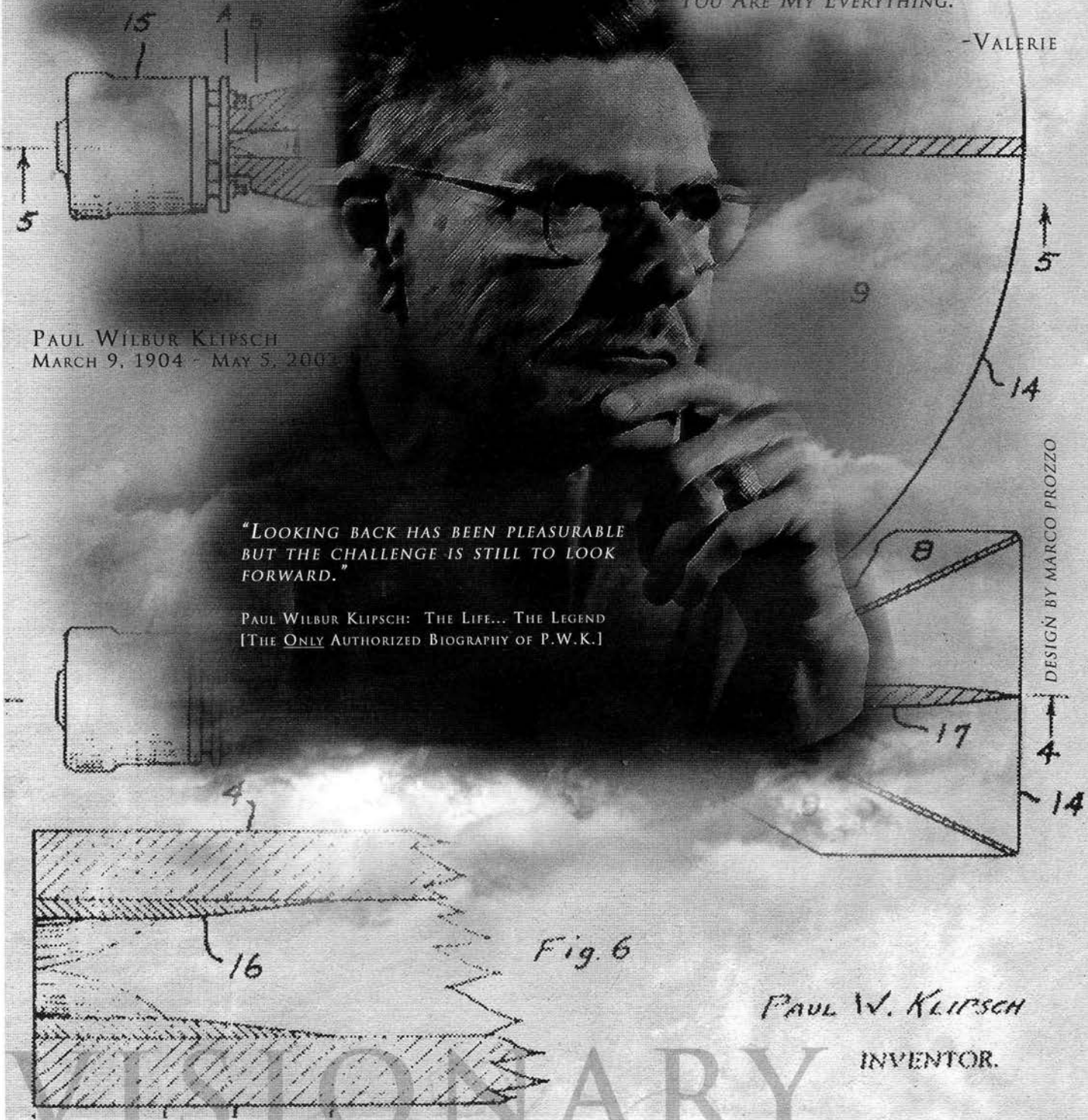

PAUL W. KLIPSCH  
INVENTOR.



# EXTINCT?

You might think so, but we've probably got what you're looking for!

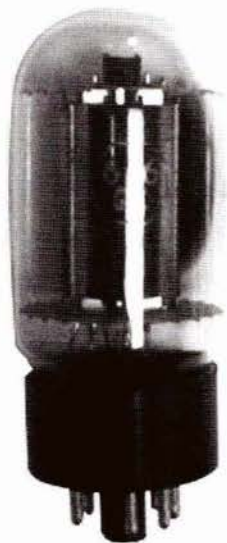

If you're looking for that unique mix of new and vintage components for a special project, Antique Electronic Supply has the right equipment. There's a good chance that we carry everything you're looking for, all in one place.

We specialize in vacuum tubes, both new-old stock and current production, and each tube comes with a guarantee! We also have a huge variety of transformers, capacitors, speakers, supplies parts, and books related to vacuum tube technology.

Contact us today to receive a free 100 page catalog or visit our website!



6221 S Maple Ave Tempe Arizona 85283 ph: 480.820.5411 fax: 480.820.4643 of 800.706.6789 e-mail: info@tubesandmore.com

[www.tubesandmore.com](http://www.tubesandmore.com)